



Amazon Bubbler Shown With Optional Display

AMAZON BUBBLER

CONTENTS & WARRANTY

This user manual is a guide for the Amazon Bubbler. For more information, updated manuals, brochures, technical notes, and supporting software on the Amazon Bubbler, please refer to ysi.com/Amazon or contact your sales representative.

For additional assistance, please contact us at +1.435.753.2212 or sales@waterlog.com

| | | | |
|--|----|--|----|
| Warranty | 1 | Logging / Data Menu..... | 38 |
| Chapter 1: Introduction | 2 | System Setup Menu..... | 40 |
| Bubbler Features..... | 3 | SDI-12 Menu..... | 42 |
| Chapter 2: Getting Started | 5 | 4-20 mA Menu..... | 43 |
| What's in the Box..... | 6 | Modbus Menu..... | 44 |
| Product Description..... | 7 | Ethernet menu..... | 45 |
| Initial Testing..... | 9 | Chapter 6: SDI-12 Interface | 50 |
| Power-up..... | 9 | Default Setup..... | 50 |
| Communicate..... | 9 | SDI-12 Address..... | 50 |
| Using the Amazon with Display..... | 9 | Level Units / Slope..... | 51 |
| Using the Amazon Web Interface..... | 10 | Set Current Level..... | 52 |
| USB Wi-Fi Connection..... | 11 | Level Offset..... | 53 |
| USB Cable Connection..... | 11 | Level Averaging Time..... | 53 |
| Amazon Graphical User Interface..... | 12 | Bubble Rate..... | 54 |
| Chapter 3: Installation | 13 | Purge..... | 55 |
| Water Depth..... | 14 | Purge Pressure..... | 56 |
| Mounting..... | 14 | Purge Sustain..... | 56 |
| Desiccator..... | 14 | 4-20 Milliamp Output..... | 57 |
| Orifice Line..... | 15 | 4-20 Milliamp Min Level..... | 57 |
| Power Wiring..... | 15 | 4-20 Milliamp Max Level..... | 58 |
| Chapter 4: Setup & Operation - Software | 16 | Modbus Mode Enable..... | 59 |
| Software Interface..... | 17 | Help..... | 59 |
| Navigation Pane..... | 17 | Chapter 7: Modbus Operation | 60 |
| Current Screen Content..... | 17 | Modbus..... | 61 |
| Site ID, Connection, and Status..... | 17 | Communication Setup..... | 61 |
| Home Page..... | 17 | Function Codes..... | 61 |
| Bubbler..... | 20 | Modbus Command Examples..... | 65 |
| Data..... | 23 | Chapter 8: Appendix | 67 |
| SDI-12..... | 26 | Appendix A: Orifice Line Installation..... | 68 |
| 4-20 mA..... | 26 | Appendix B: Error Codes..... | 70 |
| Modbus..... | 27 | Appendix C: Specifications..... | 72 |
| Cell Modem..... | 29 | | |
| Storm Central..... | 29 | | |
| System Setup..... | 31 | | |
| Ethernet..... | 33 | | |
| Chapter 5: Setup & Operation - Keypad | 34 | | |
| Keypad - Display..... | 35 | | |
| Home Screen..... | 35 | | |
| Main Menu..... | 35 | | |
| Sub Menu Editable Fields..... | 36 | | |
| Level Sensor Menu..... | 36 | | |
| Bubbler menu..... | 37 | | |



Contents & Warranty

"PRODUCTS MANUFACTURED BY YELLOW SPRINGS INSTRUMENTS CO., INC. are warranted by Yellow Springs Instruments Co., Inc. ("YSI") to be free from defects in materials and workmanship under normal use and service for twenty four (24) months from date of shipment unless otherwise specified in the corresponding YSI pricelist or product manual.

Products not manufactured, but that are re-sold by YSI, are warranted only to the limits extended by the original manufacturer. Batteries, desiccant, and other consumables have no warranty. YSI's obligation under this warranty is limited to repairing or replacing (YSI's option) defective products, which shall be the sole and exclusive remedy under this warranty.

The customer shall assume all costs of removing, reinstalling, and shipping defective products to YSI. YSI will return such products by surface carrier prepaid within the continental United States of America. To all other locations, YSI will return such products best way CIP (Port of Entry) INCOTERM® 2010, prepaid. This warranty shall not apply to any products which have been subjected to modification, misuse, neglect, improper service, accidents of nature, or shipping damage. This warranty is in lieu of all other warranties, expressed or implied. The warranty for installation services performed by YSI such as programming to customer specifications, electrical connections to products manufactured by YSI, and product specific training, is part of YSI's product warranty. YSI EXPRESSLY DISCLAIMS AND EXCLUDES ANY IMPLIED WARRANTIES OF MERCHANTABILITY OR FITNESS FOR A PARTICULAR PURPOSE. YSI is not liable for any special, indirect, incidental, and/or consequential damages."

A complete TERMS AND CONDITIONS OF SALE can be viewed at:
<http://www.ySI.com/terms-and-conditions.php>

01 / INTRODUCTION

WATER LOG

Amazon

Power

Status



The Amazon is a “Powered by Storm” bubbler system. Like its H-3553T predecessor, the Amazon is a “compact-combo” system because of its small size and built in calibrated pressure sensor with the bubbler system. Designed to produce a precision constant mass flow of gas, the Amazon system is used to measure fluid levels in applications such as surface water (streams and lakes, etc.), ground water and tanks.

“Powered by Storm” means that the bubbler provides that same key functionality of the Storm 3 data loggers. These include:

- Wi-Fi connectivity to smart phones, tablets, and computers.
- Direct connectivity to our Storm Central Data Hosting solutions via Ethernet.
- Simple user configuration with browser based software.

The Amazon is a stand-alone system that can record data and push this data to the Storm Central Data Hosting, as well as to be used as a sensor connected with any data logger, PLC, RTU, or Data Collection Platform (DCP). It works seamlessly with any SDI-12 recorder device.

The Amazon bubbler system uses a battery operated compressor to maintain pressure in an internal tank. A microprocessor determines how much pressure is needed in the tank, based on the current head pressure, to produce a constant bubble rate. The compressor and tank replace the dry nitrogen tank used in previous systems.

A sophisticated system of sensors and valves regulate the bubble rate and purge pressure. This portion of the Amazon replaces the sight feed flow controller and pressure regulator (Conoflow system) used in previous systems.

The Amazon bubbler system also provides a purge feature which temporarily pumps up the tank to a high pressure and opens a valve to apply high pressure to the orifice line. This feature is designed to remove any sediment that may have collected in or around the outlet of the orifice line.

Key Features:

- Easy to use standalone web browser menu setup
- Connection to web browser via Wi-Fi wireless connection, USB port, or RJ-45
- Built in calibrated pressure sensor
- RS-485 MODBUS Client/Slave device (available in V1.2 or later)
- Auto update mode, measures itself based on user defined rate
- SDI-12 interface, 4 - 20mA output, and RS-485 MODBUS data output

Keypad Features:

- ‘Update’ button causes the Amazon to initiate a new measurement
- ‘Purge’ button causes the Amazon to initiate a line purge
- ‘Tank’ button causes the Amazon to release the pressure from the tank
- ‘Cal’ button causes the Amazon to verify the sensor.
- Optional continuous display readout always shows last measured value
- Optional continuous display menu provides complete system configuration and data retrieval

CH1: INTRODUCTION

Features:

- Provides a continuous gas flow
- Battery operated - Low power
- Microprocessor controlled, "smart" gas system
- One-piece manifold eliminates many potential sources of leaks
- Digital pressure gauge provides a visual indication of the tank pressure
- Hydrophobic intake membrane, protects compressor
- Piston type compressor does not have a "diaphragm"
- Provides an internal pressure relief valve
- The Amazon is designed and rated for extreme temperature (-40 ° to +60 ° C) operation
- Controlled and monitored as an SDI-12 sensor

02 / GETTING STARTED



Amazon



CH2: GETTING STARTED

Before installing, setup and operation of the Amazon bubbler system in the field read through this section for a general overview of what you have and how to use it.

What's In The Box?

When unpacking your Amazon, make sure all the components ordered are received and undamaged from shipping (any concerns please let us know at +1-937-767-2772 or support@waterlog.com). The basic package includes the following:



Amazon Bubbler

*Amazon shown with optional display



Power/Communication Terminal Blocks



Outlet Fitting



Wi-Fi Adapter



Getting Started Guide



USB Communication Cable

Common Optional Items:

- H-355-DES - Desiccating Air Dryer
- H-355-INS - Orifice Installation Kit
- H-355-OL - Orifice Line (1000 ft minimum)
- H-355-DP - Replacement Air Dryer Desiccant
- H-SDI-CABLE - 4-Conductor SDI-12 Communication Cable

Please verify you have received these components and any other optional equipment you may have ordered.

Product Description

I/O Panel Connections

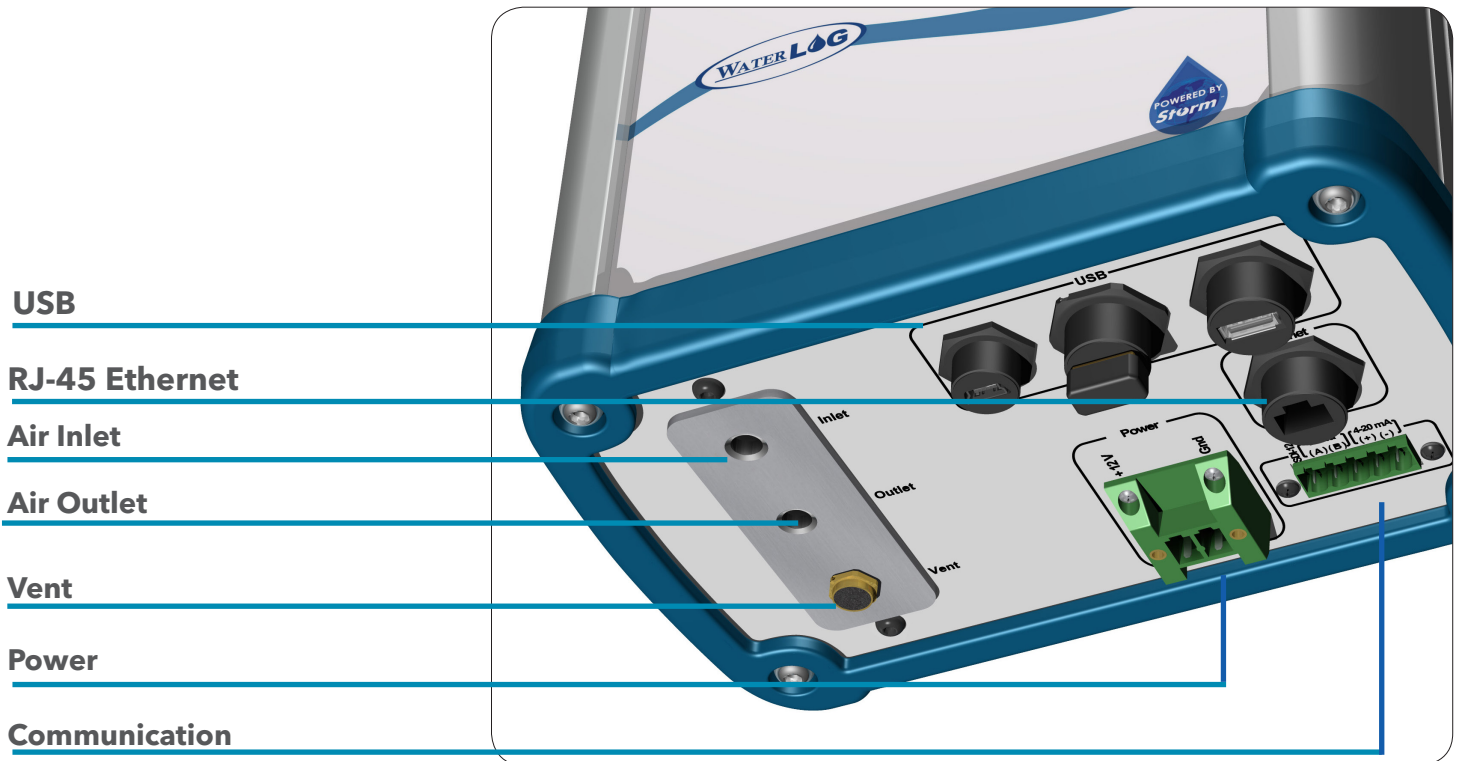

CH2: GETTING STARTED

Identify Front Panel Connections

Display and Control Buttons (Display Optional)

Power and Status LEDs

 **Cal Button**

 **Purge Button**

 **Tank Button**

 **Wi-Fi Button**

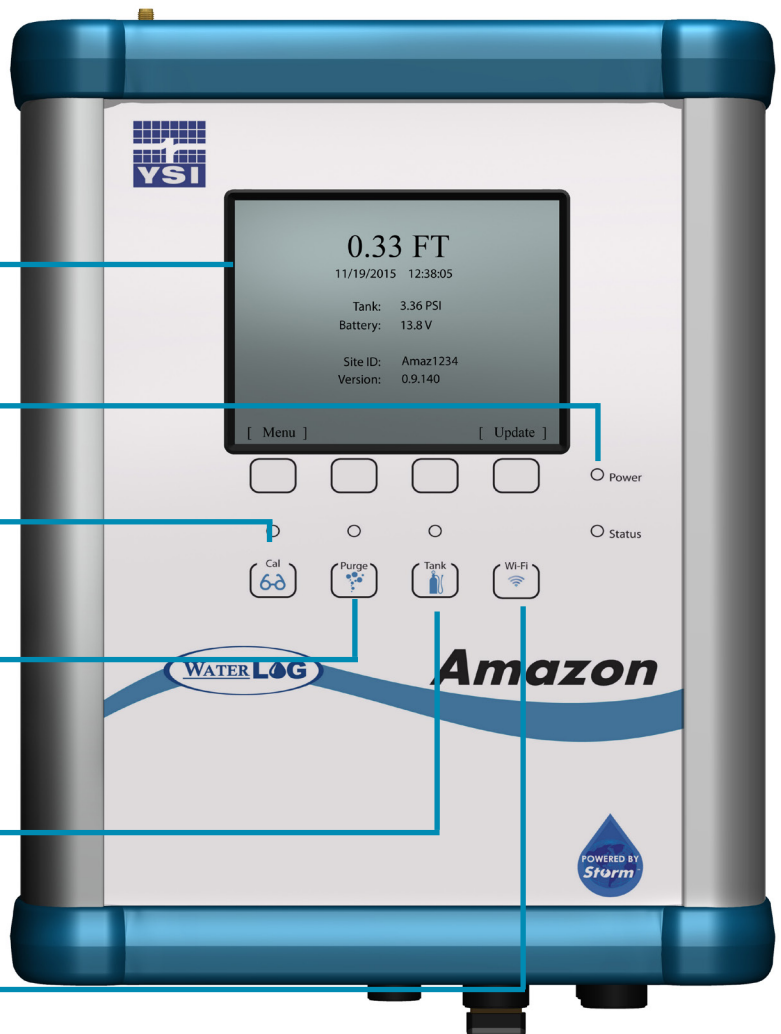

Note: All buttons on the top panel are capacitive buttons and therefore may not work if using gloves.

Initial Testing

Before installing the Amazon bubbler system in the field, it is a good practice to test the system in the shop or lab. This will help preparations for a successful field install.

Power Up

Follow these steps to power up the Amazon:

1. Apply +12v to the two position connector; +12VDC and Gnd terminal connections.
2. At power up, the Amazon will take an initial atmospheric measurement (listen for a “click” while the sensors are switched to atmosphere) and then if needed the compressor will turn on to initialize the tank pressure.



2-position Connector

Communicate

The Amazon bubbler system is designed to communicate in three different methods: USB cable to PC, Wi-Fi wireless to smart phone, tablets, or PC, or the optional display.

Using the Amazon with Display

The optional Amazon display uses a Sharp® Memory LCD that creates a clear image which is easy to see even in bright light, it also requires extremely low power. This allows the Amazon display to always be on.

Home Screen

The Home Screen displays the current water level and units of measure. It also displays the date and time of the last measurement, the live tank pressure, battery, current site ID, and firmware version. The **Menu** button takes you to the main menu. The **Update** button initiates a new measurement.

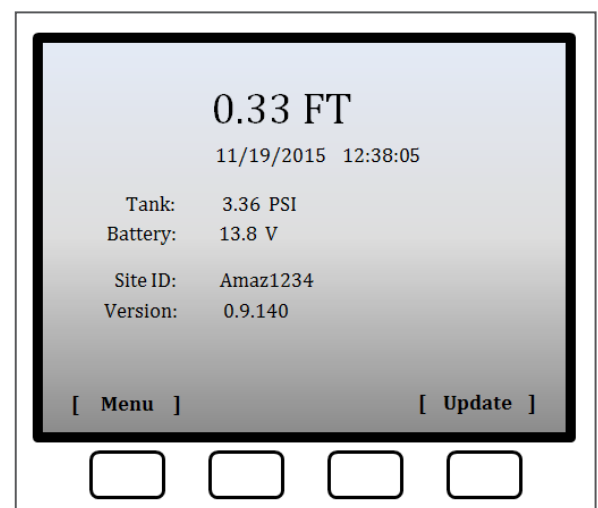

CH2: GETTING STARTED

Main Menu

The Main Menu lists all sub-menus. Move the cursor to the desired sub-menu with the up and down buttons and press enter. The cancel button will take you back a screen. To set up the site ID and set the date and time, navigate to the System Setup Menu and press **enter**.

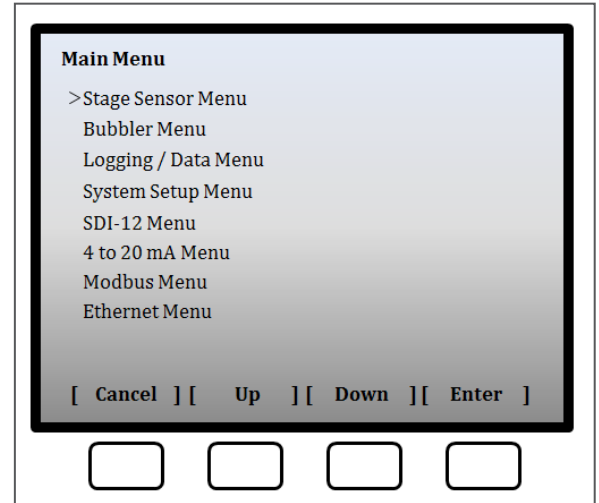

System Setup Menu

The System Setup Menu is divided up into six sections: System Setup menu, Battery, Date/Time, Wireless Settings, System Configuration and Software Update. Navigate by moving the cursor up and down to the desired setting and press enter. If the setting is editable the first character will be highlighted in black. Change the character by pressing the up and down button and scroll through the options. When you have the character you want press the right button to move the highlighter sequentially left to right changing the desired characters by scrolling up and down through the options. Once you are satisfied with the setting, scroll to the right to move the highlight past the available characters. You will see that the buttons for right and left have now changed back to cancel and enter and the setting is changed. You are now free to scroll up or down to you next setting.

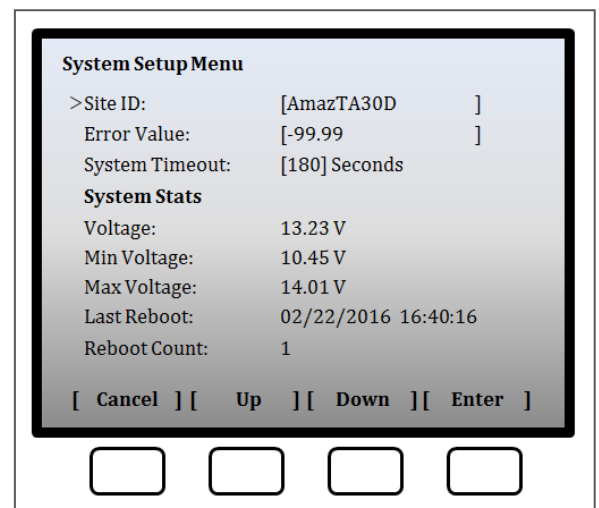

Scroll to System ID and press enter. Follow the explanation above to select the desired System ID. Next scroll to System Date and then to System Time making changes if needed. Press cancel to get back to the main menu.

Using the Amazon Web Interface

The Amazon can connect to a browser wirelessly through the Wi-Fi adapter, Ethernet port, or by the USB communication cable. Both methods give access to the Amazon GUI (Graphical User Interface) which provides a simple to use interface to setup the Amazon configurations, data logger, and data retrieval.

USB Wi-Fi Connection

To wirelessly connect to the Amazon, either plug in the USB Wi-Fi adaptor, or if the Wi-Fi adaptor is already connected to the Amazon, press the Wi-Fi button on the top panel to enable the Wi-Fi connection. The Amazon will begin setting up a Wi-Fi hotspot. After a few seconds an internal LED on the Wi-Fi adaptor will begin blinking, indicating the hotspot connection is ready. The hotspot connection will typically become available within ten seconds. Once the hotspot is active, navigate to the Wi-Fi networks setting of your Wi-Fi enabled device. Refreshing the list should reveal an Amazon Wi-Fi hotspot. Connect to the hotspot - this generally occurs within ten seconds. After successfully connecting, open a web browser (the default hot spot is AmazXXXXX) and navigate to <http://172.20.20.20/>. If the hotspot connection was successful, the Amazon user interface will appear in the browser.



Wi-Fi button on front of the Amazon Bubbler

Note: All buttons on the top panel are capacitive buttons and therefore may not work if using gloves.

IOS

Wireless networks appear under the "Settings" application, listed under the Wi-Fi topic. Wireless networks are automatically refreshed every few seconds. Simply touch a network to connect to it. A checkmark will appear next to the network once a connection has been made. Open the Safari web browser and navigate to <http://172.20.20.20/>.

Windows 7

Wireless networks appear under the "Network Status" icon in the system tray, next to the clock. Left click on the Network Status icon to show available wireless networks. The listing of wireless networks can be refreshed by pressing the Refresh button in the upper right corner. Select the Amazon network and press the Connect button. Once the connection has been established, open Internet Explorer and navigate to <http://172.20.20.20/>.

USB Cable Connection

To connect directly to the Amazon, the supplied USB device cable can be used. The first use of the device cable will require a simple driver to be installed for communication. After the driver has been installed, a new network connection will be established with the Amazon. This typically occurs within ten seconds. Once the network has been established, open a web browser and navigate to <http://172.20.20.20/>. If the connection was successful, the Amazon's user interface will appear in the browser window.

CH2: GETTING STARTED

Windows Driver Installation

Windows 7 Driver Installation First-Time use of the Amazon with a PC will attempt to automatically install the drivers for the Amazon. **As the drivers will not be automatically discovered, the driver will need to be manually installed. This can be done through the Device Manager.** To open the Device Manager, first navigate to the Control Panel, then System and Security > System > Device Manager (or just System > Device Manager if using classic icons). Look for a device labeled RNDIS with an exclamation mark next to it. Right click on the RNDIS label and select Update Driver Software. Select "Browse my computer for the driver software". Click the option to "Let me pick from a list of device drivers on my computer." On the device type screen, choose "Network adapters" and click next. On the Select Network Adapter screen, select "Microsoft Corporation" as the Manufacturer followed by "Remote NDIS Compatible Device" as the network adapter. Click Next. A warning will appear stating that Windows cannot verify that the driver is compatible with your hardware. Click Yes to install it anyway and the driver installation is complete.

The driver only needs to be installed on the first connection for this device. After the driver has finished, disconnect and reconnect the USB device cable to initialize the network connection. Once the connection has been established, open a web browser and navigate to <http://172.20.20.20/>.

Note: The user interface will be displayed on only one hardware connection (Wi-Fi or USB device cable) at a time. The USB Wi-Fi connection takes precedence when plugged in. Thus if using the USB device cable, be sure to have the USB Wi-Fi adaptor unplugged from the Amazon. If the USB device cable is currently active, the Wi-Fi adaptor will have no effect when plugged in (i.e. the Wi-Fi signal will not be activated). The USB device cable supports a single connection whereas multiple devices can connect to the Wi-Fi adaptor at the same time.

Amazon Graphical User Interface

The Web interface is a point and click environment. Editable settings are either selectable by drop down menu or manually entering the option.

Home Screen: Set Site ID, Date and Time and view the System Status.

Bubbler Screen: Set your Units of Measure, Offset, Level, Value as well as the purge and bubble settings.

Data Screen: Set the Amazon's logging settings and data management.

SDI-12 Screen: Set the Amazon's SDI-12 address.

4 to 20: Set the 4 to 20 mA output settings.

Modbus: Set Modbus settings.

Cell Modem: (under development)

Storm Central: Set Server configuration settings.

System Setup: Set Advanced System settings.

Ethernet: Set Ethernet settings.

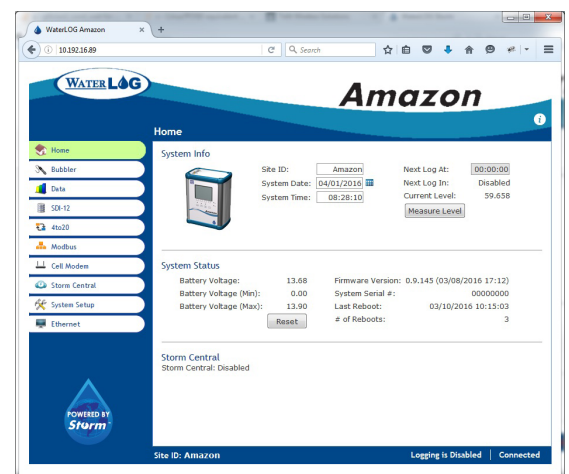

Web Interface Home Screen

03 / INSTALLATION

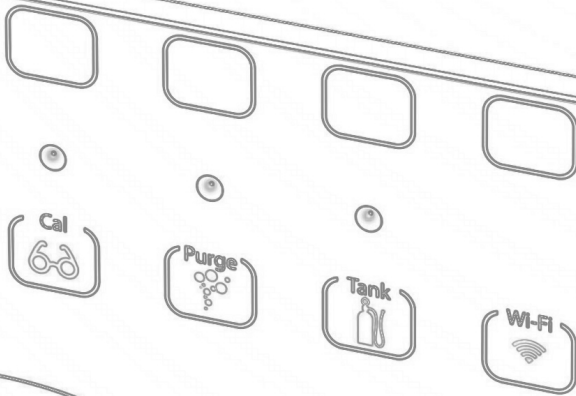

● Power

● Status

WATER LOG

Amazon



CH3: INSTALLATION

The Amazon bubbler system includes a fully integrated digital pressure transducer specifically designed for water level monitoring. The Amazon directly measures dry gas over a broad temperature range.

WARNING! Before proceeding with the installation, please consider the following site preparation steps to help prevent problems later.

Water Depth

Table 3-1 shows the maximum pressure to which the Amazon is factory calibrated to measure.

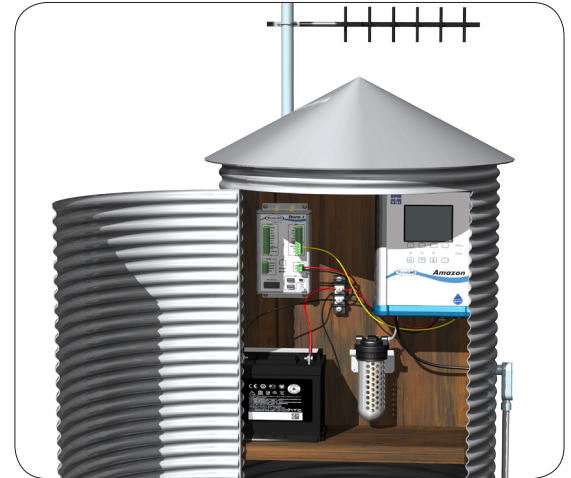

Amazon Bubbler in Gauge House

Table 3-1: Amazon Models Pressure Ranges

| Model | Pressure Range | Water Depth Range* | Accuracy |
|------------|----------------|------------------------|----------------------|
| Amazon 150 | 0 to 15 PSI | 0 to 10.54m(34.6 Ft) | +/- 2.1mm(0.007 Ft) |
| Amazon 300 | 0 to 30 PSI | 0 to 21m(69.2 Ft) | +/- 4.26mm(0.014 Ft) |
| Amazon 500 | 0 to 50 PSI | 0 to 35.16m(115.35 ft) | +/- 7.03mm(0.023 Ft) |

***NOTE:** Depth calculations are derived from the standard equation that one PSI is generated by a column of fresh water 0.70325m (2.3067 ft) deep.

Mounting

Consideration should be taken in properly mounting the Amazon bubbler system. Mount the Amazon in a location where it will not get jarred or shift during operation.

When possible mount all equipment with connectors pointing down so that moisture or condensation that could rest on the connectors does not penetrate the inner components of the equipment. Also, specifically with the Amazon, having it mounted vertically helps prevent moisture from migrating to the valves. If moisture does migrate, it will migrate first at the bottom of the tank and near the nylon plug.

Desiccator

An external desiccator is required to dry the compressor intake air. The desiccator prevents accumulation of moisture in the tank, manifold and other areas in the system. Moisture inside the bubbler will degrade the measurement accuracy and damage the manifold and compressor. Connect the output of the desiccator to the port marked "Inlet". Desiccators which employ "indicating" silica gel have the advantage of visually showing the status of the desiccant. As the gel becomes saturated with moisture the gel changes from blue to pink.

Orifice Line

The position and installation of the orifice line is vital to a successful and accurate Amazon installation. These are just a few of several things to consider when installing or checking an orifice line installation. Refer to Appendix A and Application Note 1005 for more detailed information about orifice line installation (http://www.waterlog.com/media/pdfs/orifice-line-installation_001.pdf).

Be sure the water current or flow is not pushing against the end of the orifice line, as it will cause a pressure to be placed on the line that is not related to the water depth. Also, be sure the water current or flow is not pulling or drawing from the end of the orifice line, as this will cause a false lower pressure on the line not related to the water depth. The line should be installed in an area where the flow of water will remain relatively calm as compared to the real level changes. Here are a few Do's and Do Not's on mounting the line.

Do:

- Mount the outlet in still water
- Mount the outlet so the last inch or so is almost horizontal, with a slight downward slope
- Try to prevent swells in long runs of orifice line

Do not:

- Do not mount the outlet of the orifice line facing up stream, downstream, or upwards
- Do not allow any portion of the line to be lower than the exit point
- Do not allow "goose necks" in the orifice line
- Do not use thin walled tubing, only use **USGS approved*** orifice line
- Do not mount outlet of the orifice line in the wake of an obstruction, bridge pier, rock, etc.

*The United State Geological Survey approved tubing is 3/8" OD x 1/8" ID designed for bubbler orifice installations. Level Measurement at Gaging Stations. Chapter 7 of Book 3, Section A. USGS, Reston, Virginia:2010

Power Wiring

The Amazon requires a 10 to 16 VDC power sources. It is recommended using heavier gauge wire (about 18AWG) for this connection and connecting it directly to the + 12V battery.

When used as a sensor connected to a data logger, the power source of both the Amazon and the data logger should be to connected directly to the +12V of the battery.

Table 3-2: Amazon Wiring

| Battery | Amazon | Storm 3 |
|---------|------------|------------|
| +12V | +12V | +12V |
| -12V | Pwr Ground | Pwr Ground |
| | SDI-12 | SDI-12 |

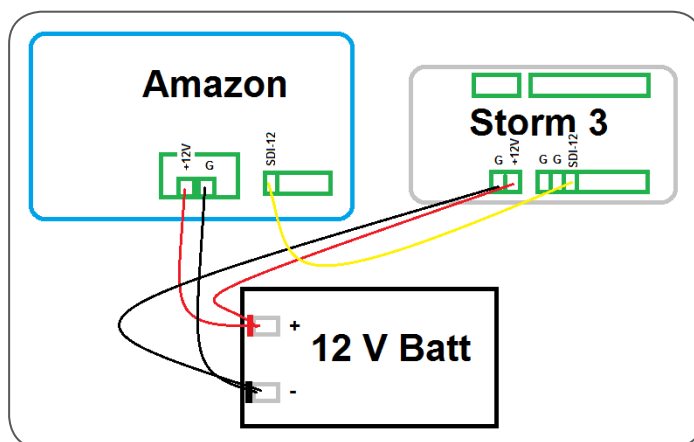
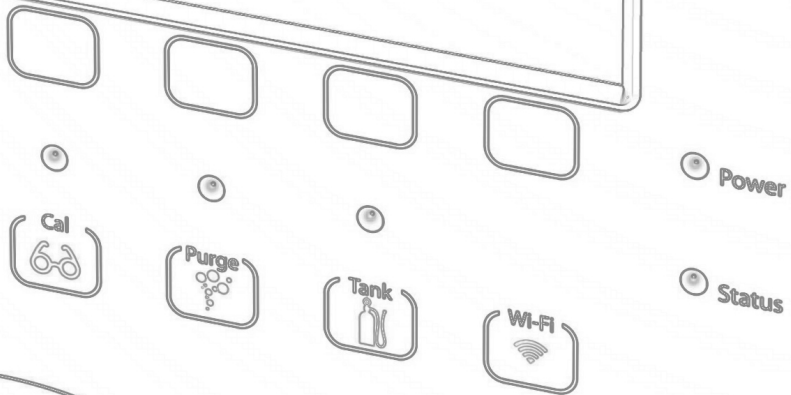

Figure 3-1: Amazon to Storm 3 Data Logger Wiring

04 / SETUP & OPERATION - SOFTWARE



WATER LOG

Amazon



There are three ways to setup the Amazon bubbler system; through the software interface, the SDI-12 interface, and through the keypad display interface. This chapter will focus on setup using the software interface. The keypad display is covered in chapter 5 and the SDI-12 commands are covered in chapter 6.

Software Interface

Once a connection to the Amazon has been established with either the Wi-Fi connection or USB connection cable, open a web browser and navigate to <http://172.20.20.20/>. The Home page will become available within the opened web browser. The GUI is divided into three main components for easy navigation.

Navigation Pane

The left side of the screen contains the navigation pane. The title of the operation in use is listed at the top of the pane with any additional screens found in the section directly below the title. The bottom of the pane has each operation listed, with the current operation in use highlighted in green.

Current Screen Content

The right side of each screen contains the content for the operation page. Contextual help is available on each screen by clicking on the "i" icon in the upper right corner. To turn the contextual help off, just click the question mark "i" icon in the upper right corner.

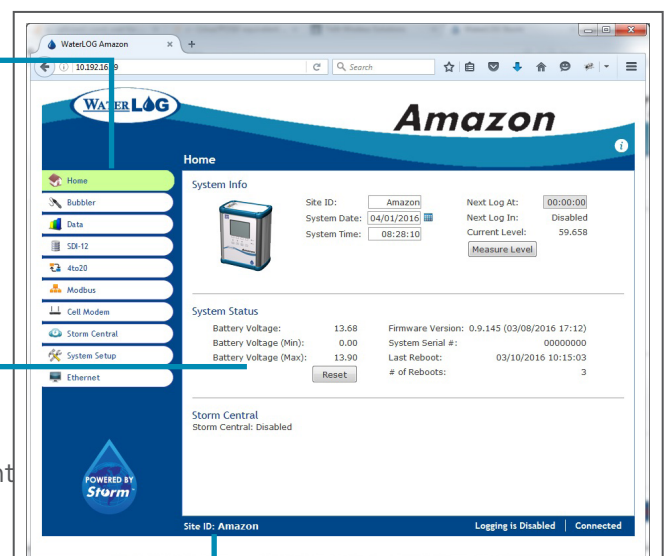

Graphical User Interface: Home Page

Site ID, Connection, and Status

The bottom of each screen contains the Site ID, Scanning status (i.e. whether the Amazon is actively taking a measurement, recording data, etc.) as well as the current connection status.

Home Page

The Site ID, date, and time can all be set on the initial Home > System Overview page. To change any of the settings, simply click on the current setting and type in a new value. To save the values, Press "Enter" or click outside the entry box.

System Info

Site ID

The Site ID can be used to identify an exact location, but it will also be used as the filename for logged data. The Amazon uses a DOS file system and since the Site ID text is used as a file name, it must fit the DOS format. This means no spaces, periods, or any non-text characters.

As you enter the Site ID, notice the color of the characters. Red colored characters mean it will not be recognized and must be deleted. Blue colored characters mean it is acceptable. Space is limited to sixteen (16) characters.

CH4: SETUP & OPERATION - SOFTWARE

System Date

Clicking either the box or the calendar icon will bring a monthly calendar forward. Just click on the current day and the date will be set.

System Time

The System Time format is in a 24-hour notation (hh:mm:ss). Once the time is set, the clock will wait to begin counting until Enter is pressed or clicking anywhere outside the box.

Next Log At

The Next Log Time format is in a 24-hour notation (hh:mm:ss). This time represents the next time the Amazon will scan the line pressure and record the value measured.

Next Log In

When logging is enabled, the 24-hour notation clock will count down how long before the next measurement will be recorded scan will occur.

Current Level

The most recent measured value is displayed. The units displayed represent the units of measurements selected in Level Units of the Bubbler section.

Measure Level

Selecting the Measure Level button will initiate a measurement and update the Current Level displayed.

System Status

The system Status section is mainly used to verify the operation of the Amazon.

Battery Voltage

The Amazon displays the current battery voltage from the systems +12 VDC input. Even though the battery voltage display will briefly rise and fall, the only voltage reading saved to your data will be at each logging interval.

Battery Voltage (Min)

Each time the Amazon measures the battery voltage it checks to see if the current voltage is less than the minimum value detected and then updates the minimum value if needed. This value is mainly provided as a diagnostic tool to help understand system performance and reliability. If the minimum voltage is too low it may indicate that the battery is being undercharged. See "Reset" below for more information.

Battery Voltage (Max)

Each time the Amazon measures the battery voltage it checks to see if the current voltage is greater than the maximum value detected and then updates the maximum value if needed. A high value may indicate a faulty regulator. See "Reset" below for more information.

Firmware Version

This is the current firmware the Amazon is running. You may be asked to provide the firmware version if you should require technical assistance.

System Serial #

The system serial number displays the Amazon serial number. You may be asked to provide the serial number if you should require technical assistance. This number should match the serial number printed on the product label found on the Amazon.

Last Reboot

The Amazon Last Reboot will be listed with date and time. Even when the system status has been reset, the last reboot will always be listed.

of Reboots

This is a status update that lists how many times the system has reset since the last system reset. A reboot can be caused by several conditions, low battery and power spikes, power glitches, and power disconnects are the most common.

Reset

The reset option is used to reset the minimum and maximum battery values, and the system reboot counter to 0. The intended use of this option is to provide information on how the system is operating between field trips. It is recommended to reset the status screens at the end of each field trip. Then, on arrival of the next field trip, the first task would be to view these numbers to see if any unexpected conditions occurred since the last trip. Ideally, the number of resets would still be zero and the min and max battery values would be within the normal operating range.

Storm Central

If the Amazon has been connected to the internet via the Ethernet port, then logged data can be pushed to Storm Central Data Hosting. Refer to the Storm Central Getting Started Guide ([http://www.waterlog.com/media/pdfs/storm-central-getting-started-guide-\(d27-02-0514\).pdf](http://www.waterlog.com/media/pdfs/storm-central-getting-started-guide-(d27-02-0514).pdf)). When setting up Storm Central, it currently only provides settings for GOES or cell modem connections. To use the Amazon with its current Ethernet IP communication, setup Storm Central as if it were a cell modem connection.

Storm Central

The Storm Central functions of the Amazon can be set to either the Enabled or Disabled mode.

CH4: SETUP & OPERATION - SOFTWARE

Next Tx

The date and time of the next transmission are displayed. This indicates the next time data from the Amazon will be pushed to Storm Central.

Last Tx

The date and time of the last transmission are displayed. This indicates the last time data from the Amazon was pushed to Storm Central.

Actual Tx

The date and time the last transmission actually occurred. This will normally be slightly after the Last Tx.

Last Tx Status

A text description of the last transmission status. Examples: "Successfully transmit x rows" or "Battery was too low to connect to server. Voltage=yy.yy".

Bubbler

The Level Settings and Bubbler Settings can all be set on the Bubbler > Overview page. To change any of the settings, simply click on the current setting and type in a new value. To save the values, Press "Enter" or click outside the entry box.

Level Settings

The Amazon includes an integrated pressure sensor that measures the pressure required to push a bubble out of the orifice line, which is the line pressure. The pressure value in psi is then converted into the desired units of measurement to represent water level. The Level Settings values provide the multipliers and offsets required to convert psi into the desired units.

Current Level

The Current Level displays the current reading in the units selected in the Level Units. Set the Current Level to the actual measured or surveyed value, this could include the elevation or not. By entering a desired Level value, the Amazon will automatically change the Level Offset as needed.

Level Offset

The Level Offset corrects for difference between the Current Level observed and the level desired. The desired level value can also be changed by entering the correct Level Offset.

The screenshot shows the 'Amazon' software interface for the 'Bubbler' section. The page is titled 'Bubbler' and contains the following settings:

- Level Settings:**
 - Current Level: 0.00
 - Level Offset: 0
 - Level Units: Feet
 - Averaging Time: 1
 - Digits: 2
 - Slope: 2.3067
- Bubbler Settings:**
 - Bubble Rate: 60 / Minute
 - Purge Pressure: 50 PSI
 - Purge Sustain: 20 Seconds
 - Timed Purge: 0 Days
 - Tank Pressure: 4.52 PSI
 - Line Pressure: 0.006 PSI
 - Last Purge (Time): 0
 - Number of Purges: 0
 - Temperature: 23.99
 - Error Code: 0
 - Status: Idle
- Bubbler Calibration:**
 - Calibrate

At the bottom of the page, it displays 'Site ID: Amazon', 'Logging is Enabled', and 'Connected'.

Graphical User Interface: Bubbler Page

Level Units

Level Units are the units of measure of the Current Level. These units will also be displayed on the key pad display. Level Units are selected from a pull down menu. When the desired units are selected from the menu, the Amazon provides the corrected slope value. The values used for conversion assumes fresh water. Use the user selected values for slope and offset if adjustments need to be made for water density variations.

Averaging Time

On the timed logging interval, external logging interval, or manual measurement request, a measurement is initiated by the Amazon. The Amazon will measure as fast as possible and then calculate the average of these readings to obtain the recorded or returned value. The longer the Averaging Time selected (entered as seconds), the more samples will be used in calculating the average. The speed at which the Amazon can obtain the samples will vary depending on several signal processing conditions. However, this frequency of samples will be between 10 and 20 samples per second. The Averaging Time can range between 1 and 360 seconds.

Digits

Select the number of digits the level or level reading will be displayed in. This refers to the number of digits after the decimal. This value must be between 2 and 6.

Slope

The Slope is calculated by the Amazon to reflect the Level Units selected. Or a user selected slope can be entered here.

Measure

The Measure button initiates an immediate measurement.

Bubbler Settings

For optimal performance under varying conditions, the Amazon provides the ability to fine-tune the bubble rate and purge functions. Where the bubble rate is directly related to the measurement, the purge functions are used to clear the orifice line of any obstructions. The purge functions can be initiated manually, on a time interval, or as an SDI-12 command.

Bubble Rate

Depending on the conditions at the site, the optimal bubbler rate will vary. This rate can be selected between 10 and 120 bubbles per minute (BPM). 60 BPM is typically used for most applications.

Purge Pressure

Purging forces a blast of air through the orifice line in order to remove any sediment or debris from the line. A line that has restriction due to obstructions can provide a false pressure reading. The pressure at which the Amazon purges the line during the purge process can be set between 40 and 90 PSI. Generally 50 PSI is adequate. Where conditions are heavily silted, a higher PSI may be needed.

CH4: SETUP & OPERATION - SOFTWARE

Purge Sustain

The time that the purge is sustained can be selected between 10 and 30 seconds. Like the purge pressure, some conditions require a longer or shorter purge time. Generally 20 seconds is adequate. Longer purge times will require higher power usage from the battery.

Timed Purge

The Amazon can be set to purge automatically. If the timed purge is not required, set the Timed Purge to 0. Time Purge is configured on a daily schedule. The frequency to purge can be set from 0 to 90 days in whole day increments. Timed Purge is activated just after noon. If 5 is entered, the purge function will activate every 5th day just after noon.

Manual Purge

Selecting the Manual Purge button will initiate the purge function based on the Purge Pressure and Purge Sustain values selected.

Reset Defaults

For most applications, the Bubble and Purge settings provided at the factory are ideal. It's easy to reset changes made back to the factory settings by selecting the Reset Defaults button.

Continuous Update

By selecting the Continuous Update button, all values under the Bubbler Settings section are measured and displayed. This is a continual measurement. Once the Continuous Update button is selected, the display will keep providing current Status data until the Stop button is selected or a new page is displayed.

Tank Pressure

Understanding the Tank Pressure can be very helpful in verifying your Amazon is working correctly. The Tank Pressure is the pressure (displayed in PSI units) of the air inside the tank. This pressure should always be at least 2 PSI's greater than the Line Pressure. The Amazon is a continuous bubbler, meaning that a bubble of air is continually being forced through the orifice line. To allow this to be continual, the tank pressure must always be greater than the pressure of the water above the outlet to the orifice line (head).

Line Pressure

The Line Pressure is pressure measured in the orifice line.

Last Purge (Time)

Regardless if a manual purge, timed purge, or programmed purge occurs, the time and date of the last purge will be displayed.

Number of Purges

The number of times the Amazon has purged will be displayed. This values reset to zero when the Reset Button is selected.

Reset

The Reset Button clears the Number of Purges back to zero.

Temperature

The temperature of the main circuit board of the Amazon is displayed. The units are selected on in the Systems Setup page.

Error Code

The Amazon is continually monitoring its own functions and health. The numbers displayed represent an error code to determine which functions are not performing properly. In addition to the error code, a directive is provided on the Home Screen. There are four directive that may be posted: User Service, Factory Service, Call Support, Set Clock. You may be asked to provide this information if you should require technical assistance. Refer to Appendix B for an description of the error codes.

Status

The Status provides the current state of the Amazon. In most situations this will display "Idle". The text will change to "Measuring" during a measurement cycle and "Purging" during a purge cycle. These values will change when Update Values button has been selected.

Bubbler Calibration

The bubbler calibration does not calibrate the Amazon. This function is for verification of the pressure sensor from an external pressure device. This is commonly used as a field verification tool to insure that the pressure sensor is providing accurate readings. Attach an external pressure source to the Amazon output port. With the pressure applied, push the Calibrate button on the Screen or Cal button on the Amazon front panel. This will disengage the Amazon compressor from the line and measure the pressure applied. The value on the display should be the same as the pressure applied.

Calibrate

The Status provides the current state.

Data

The data logging, data download, report generation, and data display settings can all be set on the Data > Overview page. To change any of the settings, simply click on the current setting and type in a new value. To save the values, Press "Enter" or click outside the entry box.

Data Settings

These settings are used to establish your data logging parameters.

Logging Mode

Four Logging Mode options:

- Off.** Selecting "Off" disables all data logging.

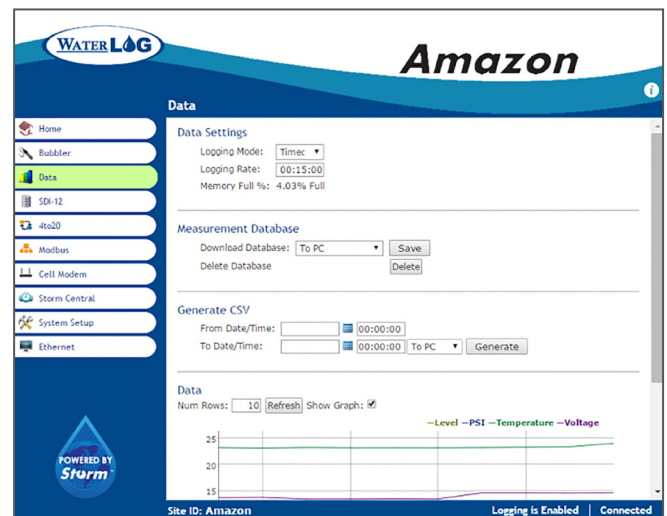

Data Screen of the Graphical User Interface Showing the Logging Modes

CH4: SETUP & OPERATION - SOFTWARE

- Timed.** The “Timed” mode enables data values to be recorded on a timed interval called the Logging Rate. When this mode is selected the Amazon will record data at each timed interval.
- External Only.** When External Logging Mode is enabled, the Amazon will record the measured data each time it receives an SDI-12 Command from a SDI-12 Recorder.
- Timed+External.** Both the Timed and External Logging Modes are enabled.

Logging Rate

The rate at which data is recorded is entered in 24-hour notations (hh:mm:ss). In the example 00:01:00, data will be recorded every minute. The logging rate must be between 1 minute and 24 hours. As you enter the Logging Rate, notice the color of each character. A red colored character means it will not be recognized.

Memory Full %

The Amazon provides 260 MB of memory. Under typical circumstances, this should provide enough memory to last for years. The units represented are the percentage of memory that has been used.

Measurement Database

The entire recorded data file of the Amazon can be down loaded in a SQLite data base file format.

Download Database

This is a selectable field. Choose which device you would like to down load stored date to. This can be directly to a PC (the Amazon is connected to a PC via the Wi-Fi, USB, or Ethernet ports) or data can be down loaded directly to a USB Flash Drive connected to the USB port on the Amazon.

Save

After the desired database has been selected, press the Save button. This will initiate data download.

Delete Database

The entire data memory of the Amazon can be cleared by selecting the Delete button. Caution should be taken before selecting this button. All data should be downloaded first to a PC or USB Flash Drive before deleting the data from memory.

Generate CSV

The more common and user friendly format for retrieving data from the Amazon is in the Comma Separate Values (CSV) format. The selected section of the data set can be retrieved and copied directly to the PC or to a USB Flash Drive.

From Data/Time

Select the beginning date and time of the first record in the data set to be retrieved. Time is the 24-hour (hh:mm:ss) format.

To Date/Time

Select the end date and time of the last record in the data set to be retrieved. Time in the 24-hour (hh:mm:ss) format.

Generate

Select the desired location to copy the data to by selecting "To PC" if the data is to be copied to the computer or "To USB" if the data is to be copied to a USB Flash Drive. The computer must be connected to the Amazon via the USB cable or WiFi connection. The USB Flash drive must be connected to the Amazon USB port. Once the desired location is indicated, select the Generate button.

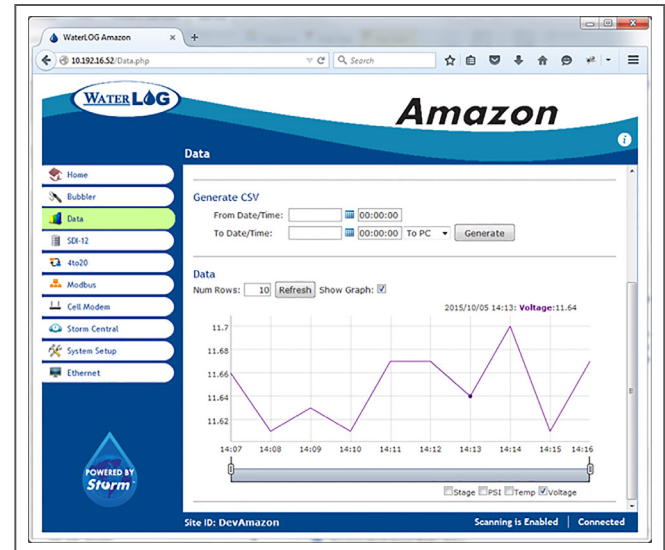

Data Screen of the Graphical User Interface showing CSV format.

Event Log

The event data logged as a text document can be copied directly the PC or to a USB Flash Drive connected to the Amazon USB port.

Download Event Log

This is a selectable field. Choose which device you would like to download stored data to. This can be directly to a PC (the Amazon is connected to a PC via the Wi-Fi, USB, or Ethernet ports) or data can be downloaded directly to a USB Flash Drive connected to the USB port on the Amazon.

Save

After the desired database has been selected, press the Save button. This will initiate data download. The word "Done!" will appear if the download was successful.

Data

For quick reference, the recorded data on the Amazon can be displayed in a graphical or table format.

Num Rows

Each data record in the data set is displayed in a row. Select the number of rows or records to be viewed in the data display. These represent the number of records that will be displayed on the graph and the table.

Show Graph

The data will be displayed in the table format if the Show Graph box is not checked. Check the box to show the data in a graph format.

CH4: SETUP & OPERATION - SOFTWARE

SDI-12

The Amazon supports all standard SDI-12 commands and uses some SDI-12 extended commands for setup operation. SDI-12 standard and extended commands are normally sent from a SDI-12 master device (recorder) like the Storm 3 data logger. Chapter 6 covers these commands in detail.

SDI-12 Settings

Multiple SDI-12 slaves can be connected to a single SDI-12 master. Each SDI-12 slave is identified by a unique address. The Amazon is an SDI-12 slave so must have a unique address.

SDI-12 Address

Acceptable address are a to z, 0 to 9, and A to Z.

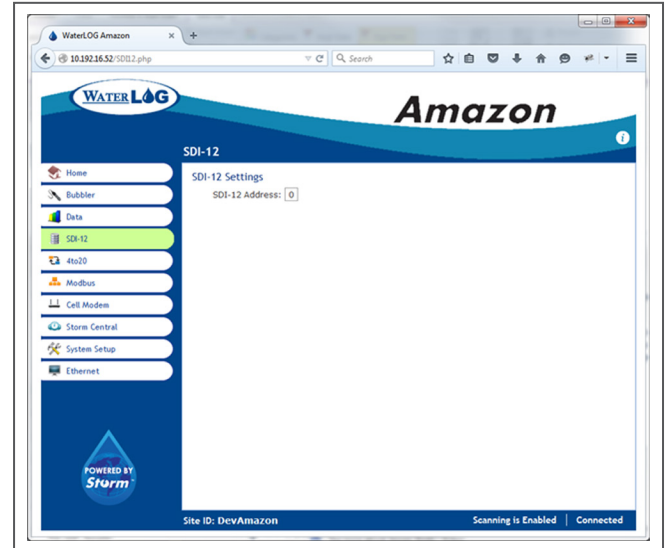

SDI-12 Screen of the Graphical User Interface

4 - 20 mA

The Amazon has the ability to output the level reading as a 4 to 20 mA signal. The Amazon controls the loop current but does not power the loop, so the loop must be externally powered.

4 - 20 mA Settings

The Amazon scales the measured level reading for the 4 to 20 mA output based on the Min and Max Level values.

Min Level

The Min Level value should be the lowest the water level gets at the installed site. The value entered is in the Level Units selected in the Bubbler section. If meters were selected as the Level Units, then the value entered here is in meters. When the actual water level measured equals the Min Value or lower, then the 4 to 20 mA output will be 4.0 mA, the minimum. There is no limit to this value, but keep in mind that the smaller the overall range of the 4 to 20 mA level scalar, which is the min to max level, the higher the resolution of the measured value will be.

Max Level

The Max Level value should be the highest value the water level gets at the installed site. The value entered is in the Level Units selected in the Bubbler section. If meters were selected as the Level Units, then the value entered here is in meters. When the actual water level measured equals the Max Value or higher, then the 4 to 20 mA output will be 20.0 mA, the maximum. There is no limit to this value, but keep in mind that the smaller the overall range of the 4 to 20 mA level scalar, which is the min to max level, the higher the resolution of the measured value will be.

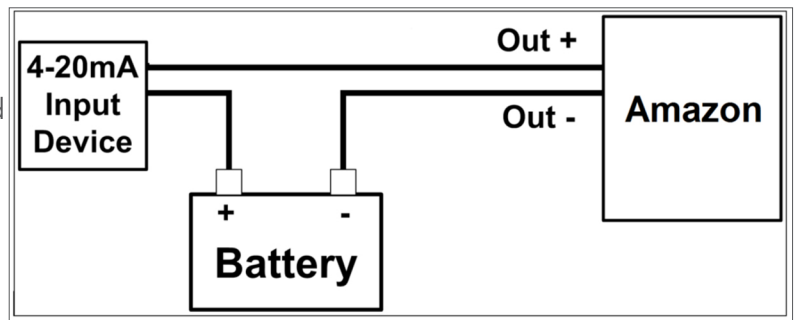

4 - 20 mA Status

The 4 to 20 mA status provides current level measurements in Level Units and the corresponding milliamps value. If a Min Level of 6 feet and Max Level of 20 feet had been entered, and the current water level where 8.45 feet, then the corresponding mA output would be 13.8 mA. The Amazon uses a straight line equation to determine the Current mA output, $y = mx+b$, where y is the desired units, m is the slope, x is the input variable, and b is the offset. Using our example converting current level to a mA output: Current mA Output 13.80 = Slope (4.0) * Current Level (8.45) + Offset (-20.00).

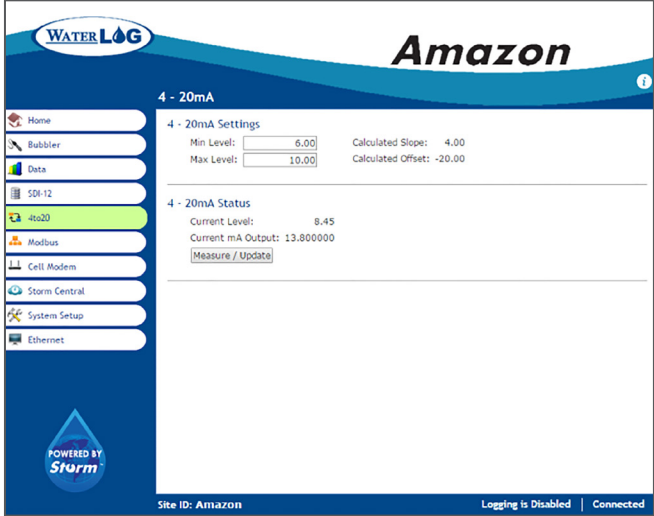

4-20 Screen of the Graphical User Interface

Current Level

This value is the measured level value in the units selected in the Bubbler section

Current mA Output

The current mA output is the corresponding mA value to the Current Level reading.

Measure/Update

Select the Measure/Update button to initiate a reading.

Modbus

Modbus is a standard communication protocol that provides communication between devices. Configured in a Master/Slave relationship, the master sends the slave a command and the slave responds with the requested data. More information about Modbus can be found in chapter 7.

Modbus Systems

The parameters available to be selected will depend on the Modbus Enabled mode that is selected.

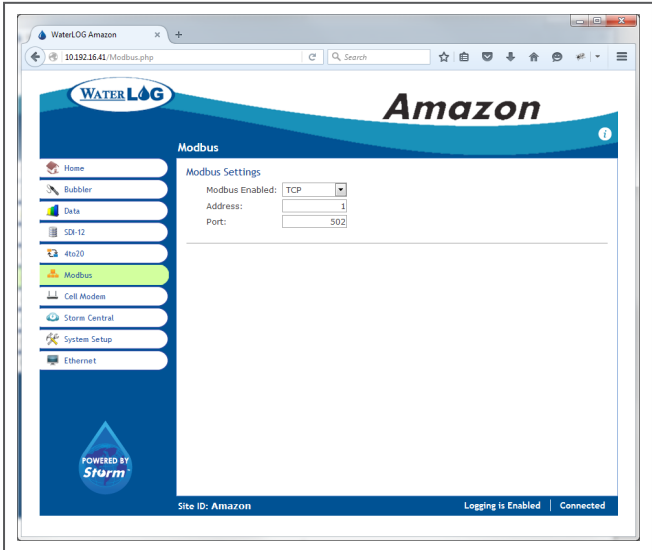

Modbus Screen of the Graphical User Interface

CH4: SETUP & OPERATION - SOFTWARE

Modbus Enabled

The Modbus Enabled setting determines whether the Amazon will communicate with a Modbus master device. The Amazon can be used as a Modbus slave. If Modbus Enabled is set to No, then Modbus communication is disabled in the Amazon. The Modbus path of communication can be via TCP, using the Amazon Ethernet port, or RS485 using the Amazon RS485 port. If TCP is selected, the required parameters are: the address and the port. If RS485 is selected, the required parameters are: the address, Baud Rate, Parity, and Mode. When the Amazon Modbus is enabled the system does not go to sleep so requires more power.

Address

Enter the address of the Modbus master that the Amazon will respond to.

Port

The TCP Port is only required if TCP Mode is selected. The default is the standard Modbus port 502. Although it may need to be changed on both ends if the default port is blocked by a gateway or firewall. The master and slave (Amazon) must use the same port to communicate.

Baud Rate

The Baud Rate is only required if RS-485 Mode is selected. The transmission speed at which the Amazon operates in serial mode. The master and slave (Amazon) must use the same baud rate to communicate.

Parity

The Parity is only required if RS-485 Mode is selected. Parity provides a simple form of error detection by appending an extra bit to each packet. The master and slave (Amazon) must use the same parity to communicate.

Mode

The Mode is only required if RS-485 Mode is selected. RTU is the standard Modbus format. It makes use of a compact, binary representation of the data. ASCII sends the character-based representation of all data. Both formats use additional CRC-based error checking. The master and slave (Amazon) must use the same mode to communicate.

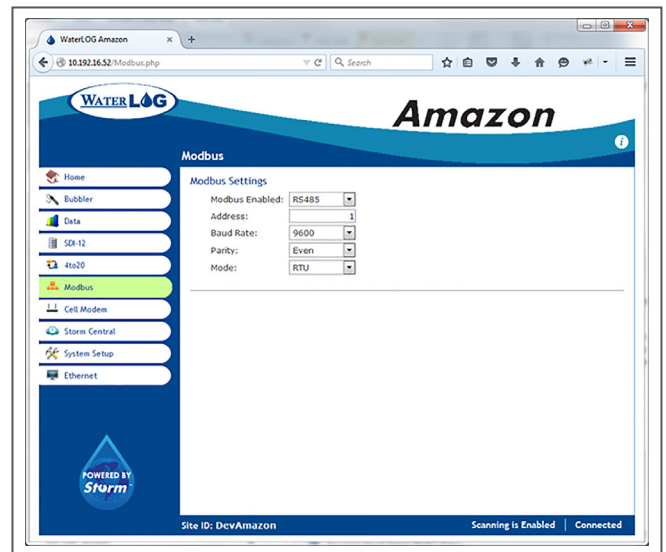

Modbus Screen of the Graphical User Interface

Cell Modem

Cell Modem is currently under development and is temporarily disabled.

Modem Settings

COM Port

Model

GSM Settings

Service Provider

Access Point Name

APN Username

APN Password

GSM Freq Band

CDMA Settings

Activation

Status

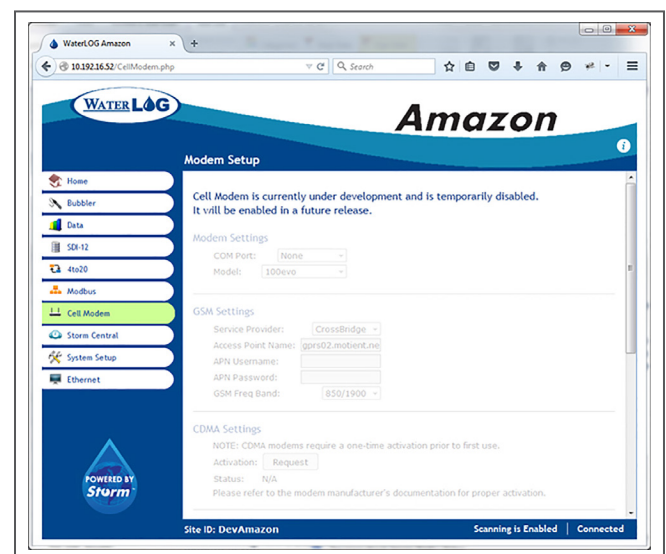

Cell Modem Screen of the Graphical User Interface

Storm Central

Storm Central is a cloud data collection service for data loggers and data collection platforms. This means that the wherever the Amazon is located, it's real-time data can be accessed 24/7/365. Once data has been collected and stored in the Amazon, it is pushed to Storm Central where it is visible within the simple and intuitive Storm Central interface. Data is presented graphically as well as tabular on the same page.

Currently remote connection to the Amazon is provided only through the Ethernet IP port. This allows the Amazon to be connected directly to the internet.

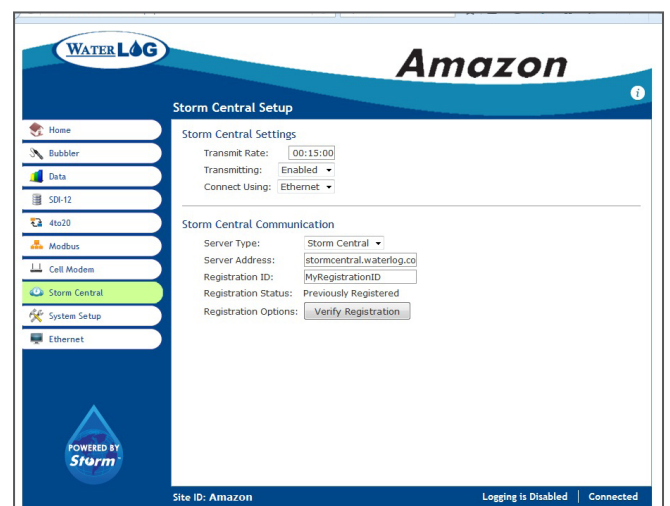

Storm Central Setup Screen of the Graphical User Interface

CH4: SETUP & OPERATION - SOFTWARE

Storm Central Settings

Systems Settings provide three configurable settings that affect the Amazon and how it displays data.

Transmit Rate

Configures how frequently to connect and transmit data to Storm Central. This function is independent of the auto-log rate and will send all data not previously sent.

Transmitting

Turn on/off the Storm Central delivery feature.

Connect Using

Options are none (this is another way to turn off data being transmitted to Storm Central), Ethernet (only used if the Amazon is connected to the INTERNET via the Ethernet port, and Modem (this feature has not been released).

Storm Central Communication

Configuration to enable the Amazon to transmit data to the desired server.

Server Type

Select between the Storm Central Server or a Custom server. The Amazon can push data to our Storm Central Data Hosted server or to other TCP servers of choice.

Server Address

Enter the IP address or DNS name of the server to deliver data to. This setting will default to stormcentral.waterlog.com.

Registration ID

The Registration ID is provided when a Storm Central account is activated. Enter the Registration ID here.

Registration Option

Once the Registration ID has been entered, select this button to register the Amazon to this account.

Registration Status

The current status if the Storm Central account is currently registered or unregistered.

System Setup

Advanced options for configuring the Amazon are located in the System Setup section.

System Settings

Systems Settings provide three configurable settings that affect the Amazon and how it displays data.

Timeout (sec)

In order to maximize power consumptions, the Amazon system reduces power by going to sleep after no activity is detected. This includes turning off the Wi-Fi connection. The Timeout setting is the amount of time in seconds that the system will wait, if no activity is detected, before going to sleep. Enter "-1" to leave the Amazon Wi-Fi in the powered on mode continuously.

Date Format

Select the desired date format that the Amazon will use to display the date stamp and record the date stamp.

Error Value

Enter the value that will be recorded if an SDI-12 data point is not returned.

Wireless Settings

The Amazon can communicate with any Wi-Fi enabled device like a smart phone, tablet or PC. When selecting the Wireless Network Connection on the device. When using the Wi-Fi connection of the Amazon, the device is recognized on the Network by its Wireless ID.

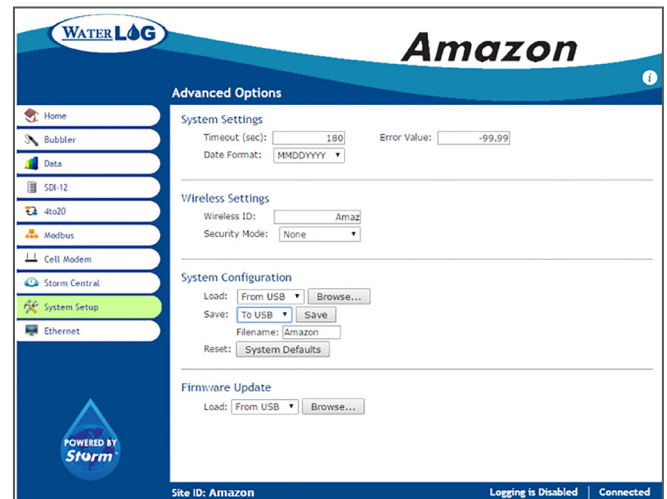

Advanced Options Screen of the Graphical User Interface

CH4: SETUP & OPERATION - SOFTWARE

Wireless ID

Enter the ID name that will identify the Amazon bubbler on the Wireless Network Connection. The name of the Wireless ID has no length restrictions and can contain letters, numbers, hyphen, underscore, and period.

Security Mode

The Amazon provides a security gate into the functionality of the system. WPA2, WPA, WPA+WPA2 must be consistent with your modem or router settings. When Security Mode is enabled the Pass Phrase becomes available.

Pass Phrase

Entered the desired Pass Phrase to limit entry through the Wi-Fi connection. Once a pass phrase has been selected, it will be required on the smart phone, tablet, or PC. WPA specs require the pass phrase to be between 8 and 63 printable characters.

System Configuration

The Amazon creates a configuration file of the settings selected when configuring the system. This file can be copied to a PC, USB Flash Drive, or the Amazon. The configuration file can then be downloaded onto another Amazon bubbler so that exact same configurations are used on each Amazon.

Load

The Load selection box provides three locations from which to retrieve a configuration file and load it onto the Amazon; From the PC, from the USB Flash Drive that is connected to the Amazon USB port, and from the Amazon. This allows multiple configuration files to be stored and retrieved as needed.

Save

The Save selection box provides three locations from which to save a configuration file created on the Amazon; to the PC, to the USB Flash Drive that is connected to the Amazon USB port, and to the Amazon.

Reset

Selecting the Systems Default button resets all Amazon configuration settings to their original factory state.

Firmware Update

There are several reasons to install a new Firmware on the Amazon. These include replacing a firmware that has become corrupted or installing a newly released firmware. All Amazon firmware versions are available on www.waterlog.com/software-archive/. These files can be copied to a PC or to a USB Flash Drive. From these storage devices the firmware can be loaded to the Amazon.

Load

Select the location where the Firmware has been saved, this can be either the PC to USB Flash Drive. Select Choose File. If the PC was selected as the location of the firmware file, then a directory from the attached PC will be displayed. If the USB was selected, then the USB directory will be displayed. Select the desired file from these locations. The firmware will have a format AmazonFWvx.x.xx.bin.

Ethernet

Ethernet Settings

The Ethernet port located on the Amazon can provide a quick and easy direct or remote connection to a PC. Using the Ethernet connection to the internet also allows the Amazon to push data directly to the Storm Central data hosting server. Refer to the Storm Central Getting Started Guide ([http://www.waterlog.com/media/pdfs/storm-central-getting-started-guide-\(d27-02-0514\).pdf](http://www.waterlog.com/media/pdfs/storm-central-getting-started-guide-(d27-02-0514).pdf)).

Ethernet Mode

DHCP can be used if plugged into a network with a DHCP server otherwise the static IP mode can be used. Care should be taken not to use an address that a DHCP server can assign. Consult with your IT department.

IP Address

When the DHCP mode is selected the IP Address is provided by the DHCP server. The IP Address field is not editable. When the Static IP mode is selected, the Static IP address is entered (e.g. 10.10.10.10)

Network Mask

When the Static IP Mode has been selected, the Network Mask is a binary bitmask that is used to determine which remote devices can send data to this device based on the sending unit's IP address. The default value (255.255.255.0) requires the first 3 of 4 numbers of the remote device's IP address to be identical. This is sufficient for most local subnets.

Broadcast Address

When the Static IP mode has been selected, set this address to receive broadcasts on the subnet.

Default Gateway

When the Static IP mode has been selected, set to send packets within the local subnet and beyond. The default gateway can be automatically discovered by switching to DHCP (if a DHCP server can be reached).

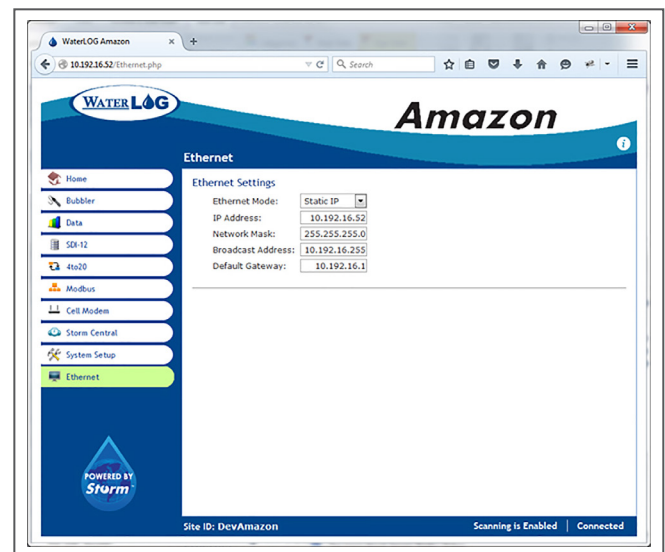

Ethernet Screen of the Graphical User Interface

05 / SETUP & OPERATION - KEYPAD

WATER LOG

Amazon

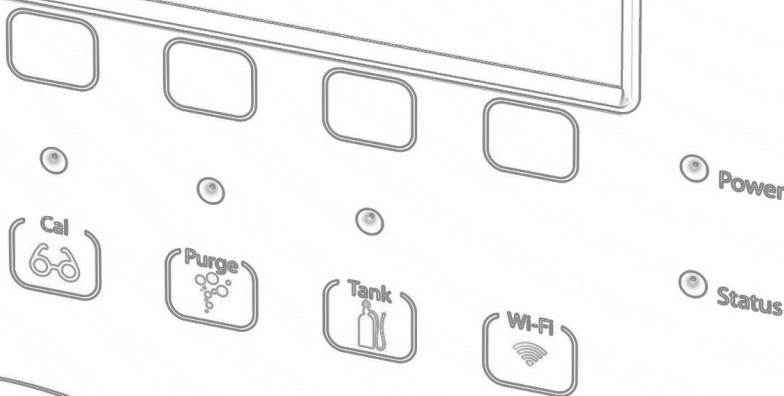

There are three ways to setup the Amazon bubbler system; through the software interface, the SDI-12 interface, and through the keypad display interface. This chapter will focus on setup using keypad display. The software is covered in chapter 4, and the SDI-12 commands are covered in chapter 6.

Keypad - Display

The Amazon's optional keypad display provides complete functionality required to configure the Amazon, retrieve logged data, and configure communication settings.

Home Screen

The Home Screen displays the current water level and units of measurement. It also displays the date and time of the last measurement, the live tank pressure, battery voltage, current site ID, and firmware version.

Menu

The menu button takes you to the Main Menu.

Update

The Update Button initiates a new measurement.

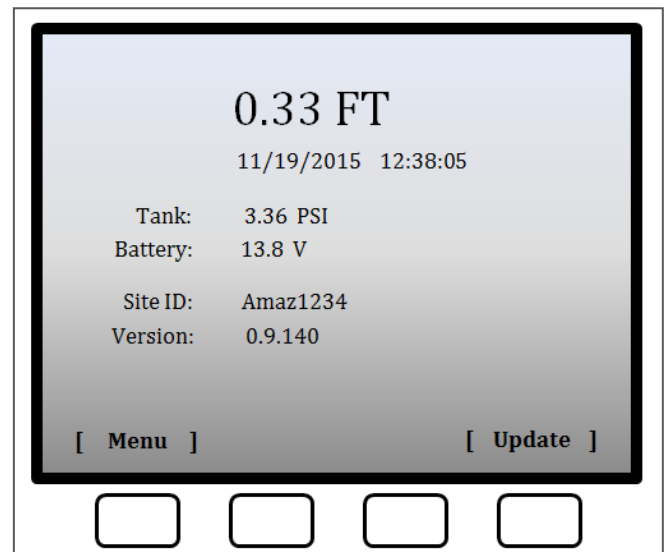

Home Screen

Main Menu

The main menu lists all sub menus. Move the cursor to the desired sub menu with the up and down buttons and press enter.

Navigating in the Main Menu

Cancel

The cancel button will take you back a screen.

Up

The up button moves the cursor up.

Down

The down button moves the cursor down.

Enter

The enter button opens the sub menu selected by the cursor.

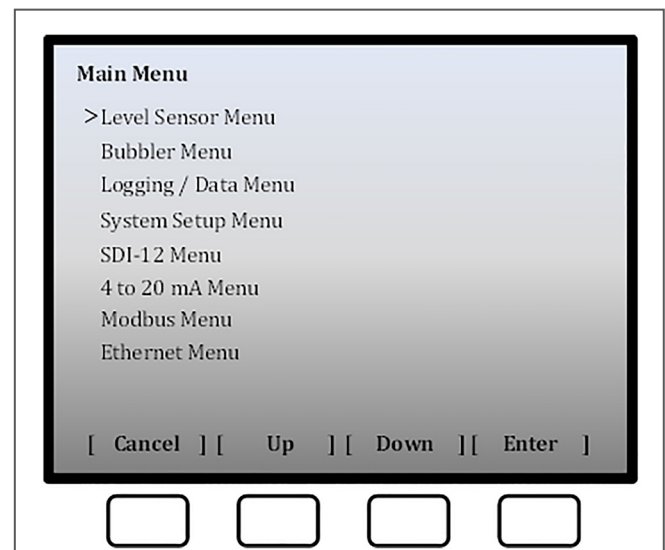

Main Menu Screen

CH5: SETUP & OPERATION - KEYPAD

Sub Menu Editable Fields

To edit fields inside the sub-menus, navigate by moving the cursor up and down to the desired field and press enter. If the setting is editable the first character will be highlighted in black. Change the character by pressing the up and down buttons. When you find the character you want, press the right or left button to move the highlighter sequentially right or left changing the desired characters by scrolling up or down through the options. Once the desired changes have been made, scroll to the right until the highlighter is moved off the field. You will see that the buttons for the right and left have now changed back to cancel and enter and the setting is changed. Entering two consecutive blank spaces inside of an editable field will delete all following characters in that field.

Level Sensor Menu

The Amazon includes an integrated pressure sensor that measures the pressure required to push a bubble out of the orifice line, which is the line pressure. The pressure value in psi is then converted into the desired units of measurement to represent water level or level. The Level Settings values provide the multipliers and offsets required to convert psi into the desired units.

Level

The Level value displays the current reading in the units selected in the Level Units. Set the current Level value to the actual measured or surveyed value, this could include the elevation or not. By entering a desired Level Value, the Amazon will automatically change the Level Offset as needed.

Level Offset

The Level Offset corrects for difference between the Level value observed and the Level value desired. The desired Level value can also be changed by entering the correct Level Offset.

Level Slope

The Slope is calculated by the Amazon to reflect the Level Units selected. Or a user selected slope can be entered here.

Level Units

Level Units are the units of measure of the level value. These units will also be displayed on the key pad Home Screen. Level Units are selected from a pull down menu. When the desired units are selected from the menu, the Amazon provides the corrected slope value. The values used for conversion assumes fresh water. Use the user selected values for slope and offset if adjustments need to be made for water density variations.

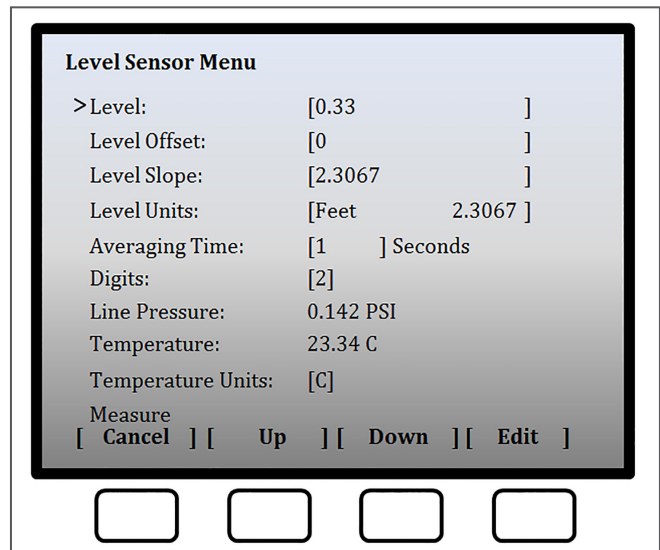

Level Menu Screen

Averaging Time

On the logging interval, programmed request, or manual request, a measurement is initiated by the Amazon. The Amazon will measure as fast as possible and then calculate the average of these readings to obtain the recorded or returned value. The longer the Averaging Time selected (entered as seconds), the more samples will be used in calculating the average. The speed at which the Amazon can obtain the samples will vary depending on several signal processing conditions. However, this frequency of samples will be between 10 and 20 samples per second. The Averaging Time can range between 1 and 360 seconds.

Digits

Select the number of digits the level reading will be displayed in. This refers to the number of digits after the decimal. This value must be between 2 and 6.

Line Pressure

The Line Pressure in PSI for the orifice tube.

Temperature

Temperature displayed is of the main circuit board of the Amazon. This represents the internal temperature of the Amazon.

Temperature Units

Enter the units in which the temperature will be displayed and recorded.

Measure

Selecting Measure will initiate the Amazon to take a new measurement.

Bubbler Menu

For optimal performance under varying conditions, the Amazon provides the ability to fine-tune the bubble rate and purge functions. Where the bubble rate is directly related to the measurement, the purge functions are used to clear the orifice line of any obstructions. The purge functions can be initiated manually, on a time interval, or as an SDI-12 command (see chapter 6) in the programming of an external data logger. The main menu lists all sub menus. Move the cursor to the desired sub menu with the up and down buttons and press enter.

Bubble Rate

Depending on the conditions at the site, the optimal bubbler rate will vary. This rate can be selected between 10 and 120 bubbles per minute (BPM). 60 BPM is typically used for most applications.

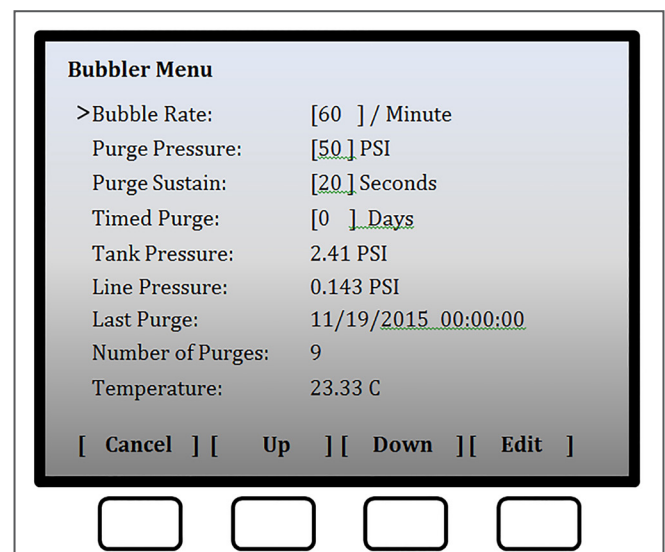

Bubbler Menu Screen

CH5: SETUP & OPERATION - KEYPAD

Purge Pressure

Purging forces a blast of air through the orifice line in order to remove any sediment or debris from the line. A line that has restriction due to obstructions can provide a false pressure reading. The pressure at which the Amazon purges the line during the purge process can be set between 40 and 90 PSI. Generally 50 PSI is adequate. Where conditions are heavily silted, a higher PSI may be needed.

Purge Sustain

The time that the purge is sustained can be selected between 10 and 30 seconds. Like the purge pressure, some conditions require a longer or shorter purge time. Generally 20 seconds is adequate. Longer purge times will require higher power usage from the battery.

Timed Purge

The Amazon can be set to purge automatically. If the timed purge is not required, set the Timed Purge to 0. Time Purge is configured on a daily schedule. The frequency to purge can be set from 0 to 90 days in whole day increments. Timed Purge is activated just after noon. If 5 is entered, the purge function will activate every 5th day just after noon.

Tank Pressure

Understanding the Tank Pressure can be very helpful in verifying your Amazon is working correctly. The Tank Pressure is the pressure (displayed in PSI units) of the air inside the tank. This pressure should always be greater than 2 PSI's than the Line Pressure. The Amazon is a continuous bubbler, meaning that a bubble of air is continually being forced through the orifice line. To allow this to be continual, the tank pressure must always be greater than the pressure of the water above the outlet to the orifice line (head).

Line Pressure

The Line Pressure is the pressure measured in the orifice line.

Last Purge

Regardless if a manual purge, timed purge, or programmed purge occurs, the time and date of the last purge will be displayed.

Number of Purges

The number of times the Amazon has purged will be displayed. This value resets to zero when the Reset Button is selected.

Temperature

Temperature in degrees, selected in the Level Sensor Menu, is of the main circuit board of the Amazon. This represents the internal temperature of the Amazon.

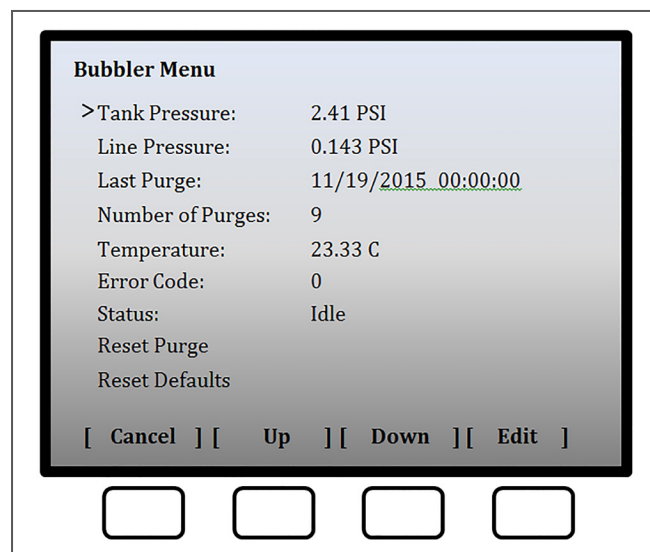

Bubbler Menu Screen

Error Code

The Amazon is continually monitoring its own functions and health. The numbers displayed represent an error code to determine which functions are not performing properly. In addition to the error code, a directive is provided on the Home Screen. There are four directive that may be posted: User Service, Factory Service, Call Support, Set Clock. You may be asked to provide this information if you should require technical assistance. Refer to Appendix B for an description of the error codes.

Status

The Status provides the current state of the Amazon. In most situations this will display "Idle". The text will change to "Measuring" during a measurement cycle and "Purging" during a purge cycle. You will also notice "Tank Maintenance" when the tank is being adjusted.

Reset Defaults

Selecting Reset Defaults will return all the bubbler configurations back to the factory defaults.

Logging/Data Menu

The data logging and data download settings can all be set on the Logging/Data Menu. The menu lists all settings. Move the cursor to the desired setting with the up and down buttons and press enter. The data points that are recorded when logging is enabled include; Date, Time, Water Level, Battery Voltage, System Temperature.

Logging Mode

Two Logging Modes are available. Move the cursor to Logging Mode and select the Enter key. This will highlight the selection box. Using the Up and Down keys, scroll through the logging options. When the desired logging mode is found, select the Enter key to enable this option.

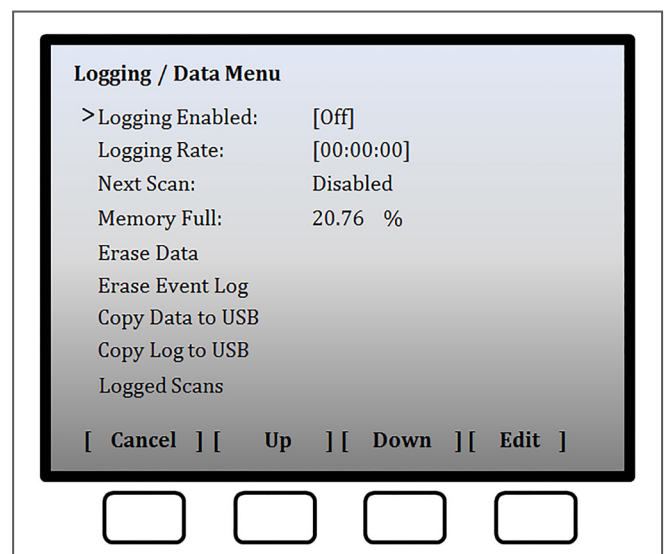

Logging / Data Menu Screen

Off. Selecting "Off" disables all data logging.

Timed. The "Timed" mode enables data values to be recorded on a timed interval called the Logging Rate. When this mode is selected the Amazon will record data at each timed interval.

CH5: SETUP & OPERATION - KEYPAD

External Only. When External Logging Mode is enabled, the Amazon will record the measured data each time it receives an SDI-12 Command from a SDI-12 Recorder.

Timed+External. Both the Timed and External Logging Modes are enabled.

Logging Rate

The rate at which data is recorded when Timed or Timed+External Logging Modes are enabled is entered in 24-hour notations (hh:mm:ss).

Next Scan

The Next Scan format is in a 24-hour notation (hh:mm:ss). This is the time when the next data will be recorded. If the Logging Mode is set to Off or External Only, then the Next Scan will be Disabled.

Memory Full %

The Amazon provides 260 MB of memory. Under typical circumstances, this should provide enough memory to last for years. The units represented are the percentage of memory that has been used.

Erase Data

The entire memory of the Amazon can be clear by selecting the Erase Data button. Caution should be taken before selecting this button. All data should be downloaded first to a PC or USB Flash Drive before deleting the data from memory.

Erase Event Log

Regardless of which Logging Mode that is being used, the Amazon records critical event data. This data includes critical information required by WaterLOG Technical Support to provide trouble shooting assistance. The event data can be cleared by selecting the Erase Event Log. Caution should be taken before selecting this button. All data should be downloaded first to a PC or USB Flash Drive before deleting the data from Event Log memory.

Copy Data to USB

Measurement data recorded in CSV format by the Amazon when the Timed, External Only, and Timed+External Logging Modes are enabled can be copied directly to a USB Flash Drive connected to the Amazon USB port. A USB Flash Drive must be connected to the Amazon before selecting the Copy Data to USB. With the USB Flash Drive connected, move the cursor to the Copy Data to USB and select the Enter button. A progress bar on the menu will indicate the memory is being copied. Once the data has been successfully copied, the word "Success" will be displayed. It is now safe to remove the USB Flash drive.

Copy Log to USB

The event data logged as a text document can be copied directly to a USB Flash Drive connected to the Amazon USB port. A USB Flash Drive must be connected to the Amazon before selecting the Copy Log to USB. With the USB Flash Drive connected, move the cursor to the Copy Log to USB and select the Enter button. A progress bar on the menu will indicate the memory is being copied. Once the data has been successfully copied, the word "Success" will be displayed. It is now safe to remove the USB Flash drive.

Logged Scans

Measurement data that has been logged on the Amazon can be viewed. This data is displayed in table format. The number of characters per data point is limited to five in each column.

| Date | Time | Level | Volts | Temp |
|------------|----------|-------|-------|-------|
| 02/24/2016 | 14:30:00 | -0.00 | 14.65 | 24.43 |
| 02/24/2016 | 14:15:00 | 00.00 | 13.50 | 23.95 |
| 02/24/2016 | 14:00:00 | 00.00 | 14.63 | 24.89 |
| 02/24/2016 | 13:45:00 | -0.00 | 14.70 | 24.17 |
| 02/24/2016 | 13:30:00 | -0.00 | 14.51 | 24.01 |

[Cancel] [Newer] [Older]

Measured Data That Has Been Logged

System Setup Menu

Advanced options for configuring the Amazon are located in the System Setup section.

Site ID

The Site ID can be used to identify an exact location, but it will also be used as the filename for logged data. The Amazon uses a DOS file system and since the Site ID text is used as a file name, it must fit the DOS format. This means no spaces, periods, or any non-text characters.

Error Value

Enter the value that will be recorded if an SDI-12 data point is not returned.

System Timeout

In order to minimize power consumption, the Amazon system reduces power by going to sleep after no activity is detected. This includes turning off the Wi-Fi connection. The System Timeout setting is the amount of time in seconds that the system will wait, if no activity is detected, before going to sleep. Enter "-1" to leave the Amazon Wi-Fi in the powered on mode continuously.

| System Setup Menu | | |
|-------------------|---------------------|---|
| > Site ID: | [AmazTA30D |] |
| Error Value: | [-99.99 |] |
| System Timeout: | [180] Seconds | |
| System Stats | | |
| Voltage: | 13.23 V | |
| Min Voltage: | 10.45 V | |
| Max Voltage: | 14.01 V | |
| Last Reboot: | 02/22/2016 16:40:16 | |
| Reboot Count: | 1 | |

[Cancel] [Up] [Down] [Edit]

System Setup Menu

CH5: SETUP & OPERATION - KEYPAD

Voltage

The Amazon displays the current battery voltage from the systems +12 VDC input. Even though the battery voltage display will briefly rise and fall, the only voltage reading saved to your data will be at each logging interval.

Min Voltage

Each time the Amazon measures the battery voltage it checks to see if the current voltage is less than the minimum value detected and then updates the minimum value if needed. This value is mainly provided as a diagnostic tool to help understand system performance and reliability. If the minimum voltage is too low it may indicate that the battery is being undercharged. See "Reset" below for more information.

Max Voltage

Each time the Amazon measures the battery voltage it checks to see if the current voltage is greater than the maximum value detected and then updates the maximum value if needed. A high value may indicate a faulty regulator. See "Reset" below for more information.

Last Reboot

The Amazon Last Reboot will be listed with date and time. Even when the system status has been reset, the last reboot will always be listed.

Reboot Count

This is a status update that lists how many times the system has reset since the last system reset. A reboot can be caused by several conditions, low battery and power spikes, power glitches, and power disconnects are the most common. See "Reset" below for more information.

Last Reset

Displays the date and time the battery voltage minimum and maximum values were reset.

Reset Stats

The reset option is used to reset the minimum and maximum battery values, and the system reboot counter to 0. The intended use of this option is to provide information on how the system is operating between field trips. It is recommended to reset the status screens at the end of each field trip. Then, on arrival of the next field trip, the first task would be to view these numbers to see if any unexpected conditions occurred since the last trip. Ideally, the number of resets would still be zero and the min and max battery values would be within the normal operating range.

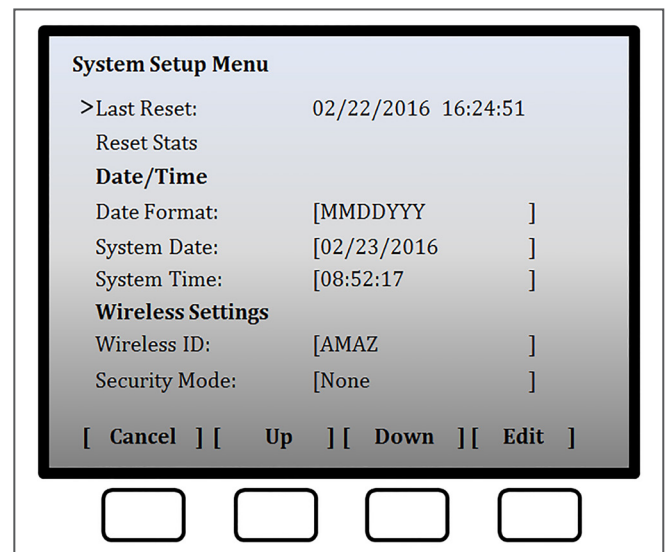

System Setup Menu Showing Last Reset

Date Format

Select the desired date format that the Amazon will use to display the date stamp and record the date stamp.

System Date

Edit the current Date on the Amazon. The date format can be changed in the Date Format selection field.

System Time

Edit the current Date on the Amazon.

Wireless ID

When using the Wi-Fi connection of the Amazon, the device is recognized on the Network by its Wireless ID. Create the Wireless ID by moving to the cursor to the Wireless ID then selecting the Enter key. Now use the Up, Down, Right and Left keys to select the desired characters. When finished, use the Right key until the cursor is out of the edit box.

Security Mode

The Amazon provides a security gate into the functionality of the system. Selecting WPA2, WPA, WPA + WPA2 must be consistent with your modem or router settings.

Pass Phrase

Entered the desired Pass Phrase to limit entry through the Wi-Fi connection. Once a pass phrase has been selected, it will be required on the smart phone, tablet, or PC. WPA specs require the pass phrase to be between 8 and 63 printable characters.

Restore Defaults

The original factory default settings can be restored by selecting Restore Defaults.

Save Configuration

Once the configuration of the Amazon has been set, these setting can be saved. This configuration is saved to the memory of the Amazon.

Load Configuration

The configuration that has been saved on the Amazon can be loaded back onto the Amazon.

Save USB Configuration

Once the Amazon configuration has been set, this file can be loaded onto a USB Flash Drive.

Load USB Configuration

You must choose a configuration file from the USB before you can load a configuration. The configuration that has been saved onto a USB Flash Drive can be retrieved and loaded onto the Amazon.

CH5: SETUP & OPERATION - KEYPAD

File

Selecting file provides a list of available firmware files saved on the attached USB Flash Drive. Insert the USB Flash Drive then scroll through the available files using the up and down buttons.

Update

Once the desired file is displayed in the file , push the update button. Software Update

Version

The current operating firmware version number is displayed.

SDI-12 Menu

The Amazon supports all standard SDI-12 commands and uses some SDI-12 extended commands for setup operation. SDI-12 standard and extended commands are normally sent from a SDI-12 master device (recorder) like the Storm 3 data logger. Chapter 6 covers these commands in detail. Multiple SDI-12 slaves can be connected to a single SDI-12 master. Each SDI-12 slave is identified by a unique address. The Amazon is an SDI-12 slave so must have a unique address. An SDI-12 device with the same address can not be connected to the same data logger at the same time. Multiple SDI-12 sensors can be connected to the same data logger at the same as long as each sensor has a unique address.

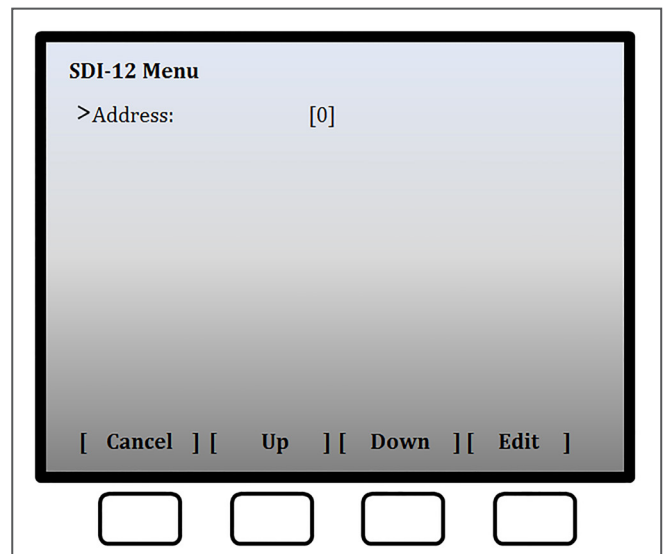

SDI-12 Menu

Address

Enter the desired address. The default address is 0. The Amazon will accept address of 0 to 9, a to z, or A to Z. Create the SDI-12 Address by moving the cursor to the Address then selecting the Enter key. Use the Up, Down, Right and Left keys to select the desired characters. When finished, use the Right key until the cursor is out of the edit box.

4 to 20 mA Menu

The Amazon has the ability to output the level reading as a 4 to 20 mA signal by scaling the measured level reading for the 4 to 20 mA output based on the Min and Max Level values. The Amazon controls the loop current but does not power the loop, so the loop must be externally powered.

Current mA Output

The current mA output is the corresponding mA value to the Current Level reading. The Amazon uses a straight line equation to determine the Current mA output, $y = mx + b$, where y is the desired units, m is the slope, x is the input variable, and b is the offset. Using our example converting current level to a mA output: Current mA Output $13.80 = \text{Slope } (4.0) * \text{Current Level } (8.45) + \text{Offset } (-20.00)$.

Min Level

The Min Level value should be the lowest the water level gets at the installed site. The value entered is in the Level Units selected in the Bubbler section. If meters were selected as the Level Units, then the value entered here is in meters. When the actual water level measured equals the Min Value or lower, then the 4 to 20 mA output will be 4.0 mA, the minimum. There is no limit to this value, but keep in mind that the smaller the overall range of the 4 to 20 mA level scalar, which is the min to max level, the higher the resolution of the measured value will be.

Max Level

The Max Level value should be the highest value the water level gets at the installed site. The value entered is in the Level Units selected in the Bubbler section. If meters were selected as the Level Units, then the value entered here is in meters. When the actual water level measured equals the Max Value or higher, then the 4 to 20 mA output will be 20.0 mA, the maximum. There is no limit to this value, but keep in mind that the smaller the overall range of the 4 to 20 mA level scalar, which is the min to max level, the higher the resolution of the measured value will be.

Calculated Slope

Based upon the values entered as the minimum and maximum level, the Amazon calculates the required slope.

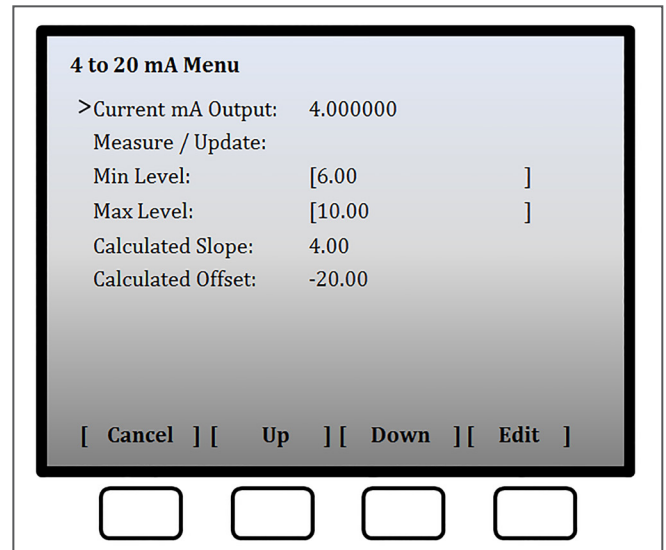

4-20 mA Menu

CH5: SETUP & OPERATION - KEYPAD

Calculated Offset

Based upon the values entered as the minimum and maximum level, the Amazon calculates the required offset.

Modbus Menu

Modbus is a standard communication protocol that provides communication between devices. Configured in a Master/Slave relationship, the master sends the slave a command and the slave responds with the requested data. More information about Modbus can be found in chapter 8.

Modbus Mode

The Modbus Mode setting determines whether the Amazon will communicate with a Modbus master device. The Amazon can be used as a Modbus slave. If Modbus Mode is set to Disabled, then Modbus communication is disabled in the Amazon. The Modbus path of communication can be via TCP, using the Amazon Ethernet port, or RS485 using the Amazon RS485 port. If TCP is selected, the required parameters are: the address and the port. If RS485 is selected, the required parameters are: the address, Baud Rate, Parity, and Mode. When the Amazon Modbus is enabled the system does not go to sleep but stays awake and based on a user defined measure rate, measures itself and updates all of the output. Being in the Modbus mode does require more power.

Address

Enter the address of the Modbus master that the Amazon will respond to.

TCP Port

The TCP Port is only required if TCP Mode is selected. The default is the standard Modbus port. Although it may need to be changed on both ends if the default port is blocked by a gateway or firewall. The master and slave (Amazon) must use the same port to communicate.

Baud Rate

The Baud Rate is only required if RS-485 Mode is selected. The transmission speed at which the Amazon operates in serial mode. The master and slave (Amazon) must use the same baud rate to communicate.

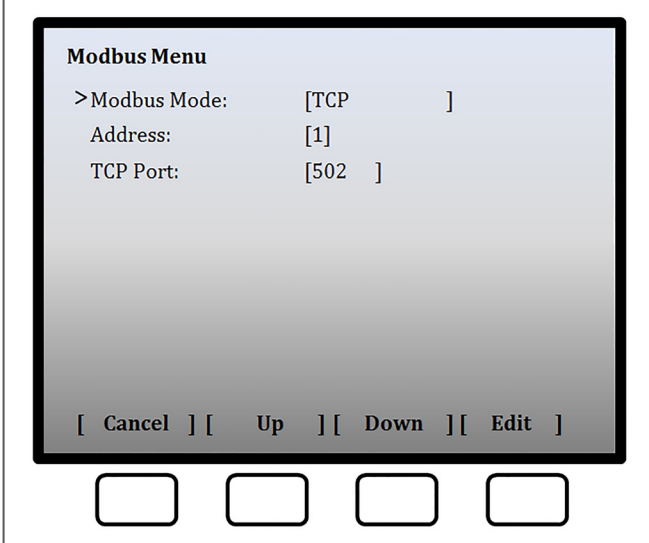

The screenshot shows a keypad interface for the Modbus Menu. The screen displays the following settings:

| Modbus Menu | |
|---------------|--------|
| >Modbus Mode: | [TCP] |
| Address: | [1] |
| TCP Port: | [502] |

At the bottom of the screen, there are four buttons labeled: [Cancel], [Up], [Down], and [Edit]. Below the screen are four physical buttons corresponding to these labels.

Modbus Menu

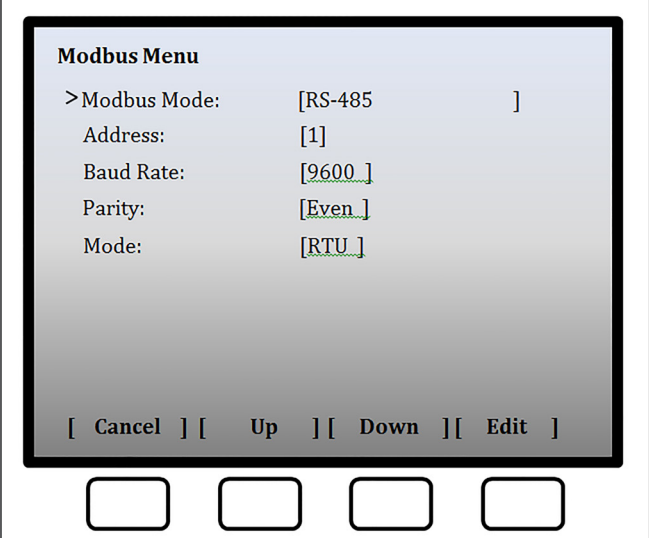

The screenshot shows a keypad interface for the Modbus Menu. The screen displays the following settings:

| Modbus Menu | |
|---------------|-----------|
| >Modbus Mode: | [RS-485] |
| Address: | [1] |
| Baud Rate: | [9600] |
| Parity: | [Even] |
| Mode: | [RTU] |

At the bottom of the screen, there are four buttons labeled: [Cancel], [Up], [Down], and [Edit]. Below the screen are four physical buttons corresponding to these labels.

Modbus Menu

Parity

The Parity is only required if RS-485 Mode is selected. Parity provides a simple form of error detection by appending an extra bit to each packet. The master and slave (Amazon) must use the same parity to communicate.

Mode

The Mode is only required if RS-485 Mode is selected. RTU is the standard Modbus format. It makes use of a compact, binary representation of the data. ASCII sends the character-based representation of all data. Both formats use additional CRC-based error checking. The master and slave (Amazon) must use the same mode to communicate.

Ethernet Menu

The Ethernet port located on the Amazon can provide a quick and easy direct or remote connection to a PC. Using the Ethernet connection to the internet also allows the Amazon to push data directly to the Storm Central data hosting server. Refer to the Storm Central Getting Started Guide ([http://www.waterlog.com/media/pdfs/storm-central-getting-started-guide-\(d27-02-0514\).pdf](http://www.waterlog.com/media/pdfs/storm-central-getting-started-guide-(d27-02-0514).pdf))

Ethernet Mode

DHCP can be used if plugged into a network with a DHCP server otherwise the static IP mode can be used. Care should be taken not to use an address that a DHCP server can assign. Consult with your IT department.

IP Address

When the DHCP mode is selected the IP Address is provided by the DHCP server. The IP Address field is not editable. When the Static IP mode is selected, the Static IP address is entered (e.g. 10.10.10.10)

Network Mask

When the Static IP Mode has been selected, the Network Mask is a binary bitmask that is used to determine which remote devices can send data to this device based on the sending unit's IP address. The default value (255.255.255.0) requires the first 3 of 4 numbers of the remote device's IP address to be identical. This is sufficient for most local subnets.

Broadcast Address

When the Static IP mode has been selected, set this address to receive broadcasts on the subnet.

Default Gateway

When the Static IP mode has been selected, set to send packets within the local subnet and beyond. The default gateway can be automatically discovered by switching to DHCP (if a DHCP server can be reached).

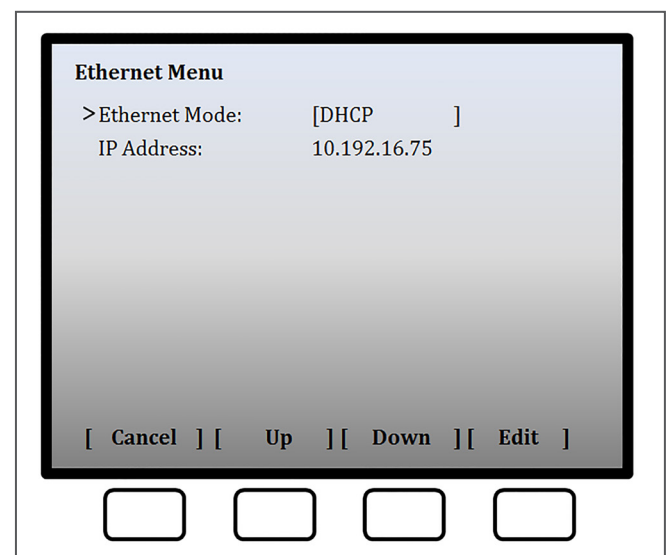

Ethernet Menu

06 / SDI-12 INTERFACE

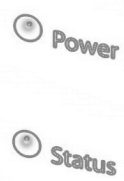
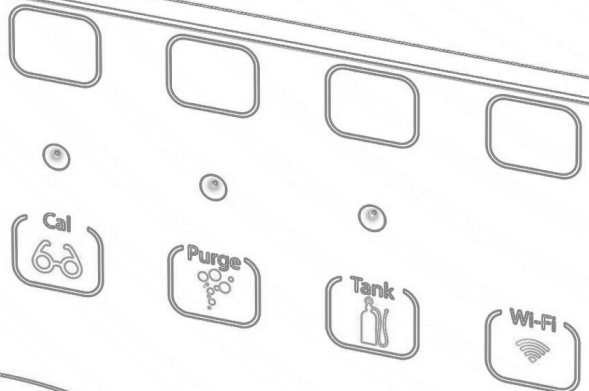

Amazon



The SDI-12 interface is another way to setup and operate the Amazon. The Amazon supports all standard SDI-12 commands and uses some SDI-12 extended (manufacturer specific) commands for setup operation. SDI-12 standard and extended commands are normally sent from a SDI-12 master device, like the Storm 3 or XL Series data loggers. Table 6-1 is a list of the standard SDI-12 commands and the extended SDI-12 commands for setting up the Amazon.

Table 6-1: Amazon Standard and Extended SDI-12 Commands

| Command | Description | Command | Description |
|---------------------------------|----------------------|--------------|----------------------------|
| <i>Standard SDI-12 Commands</i> | | | |
| a! | Acknowledge | aMC! - MC1! | Measure with CRC |
| al! | Identify | aC! - aC1! | Concurrent Measure |
| aV! | Verify | aCC! - aCC9! | Concurrent Measure w/CRC |
| aM! - aM1! | Measure | aD0! - aD9! | Data Retrieval |
| aM2! | Initiate Purge | aAn! | Change Address |
| <i>Extended SDI-12 Commands</i> | | | |
| aXSDEF! | Reset to Defaults | aXRPS! | Read Purge Sustain |
| aXRSU! | Read Slope Units | aXWPSnn! | Write Purge Sustain |
| aXWSUunits! | Write Slope Units | aXRIH! | Read 4-20mA Level Max |
| aXRS! | Read Level Slope | aXWIHnn.nn! | Write 4-20mA Level Max |
| aXWSnn.nn! | Write Level Slope | aXRIL! | Read 4-20mA Level Min |
| aXRO! | Read Level Offset | aXWILnn.nn! | Write 4-20mA Level Min |
| aXWOnn.nn! | Write Level Offset | aXRME! | Read Modbus enable |
| aXSCSnn.nn! | Auto Set Level | aXWME! | Write Modbus enable |
| aXRAT! | Read Averaging Time | | |
| aXWATnn! | Write Averaging Time | | |
| aXRBR! | Read Bubble Rate | aXRME! | Read Measure Rate |
| aXWBRnn! | Write Bubble Rate | aXWMRnn! | Write Measure Rate |
| aXRPP! | Read Purge Pressure | aXTEST! | Continuous Measurement |
| aXWPPnn! | Write Purge Pressure | aXHELP! | Display a List of Commands |
| | | aXTD! | Test Display |

Note, the 'a' character in Table 6-1 represents the current SDI-12 address of the Amazon, and the 'n' characters represent the new value to be written.

CH6: SDI-12 INTERFACE

Default Setup

The Amazon has many settings that can be change. However, the default setups will normally cover most applications. Table 6-2 shows the default settings for the Amazon.

Table 6-2: Amazon Default Setup

| Setting | Default Setting | Setting Range |
|---------------------|---|-------------------------------|
| SDI-12 Address | 0 | 0-9 (Standard), A-Z, a-z |
| Level Units | Feet (Slope = 2.3067) | Ft, In, M, mm, Ft Dn, Usr Def |
| Level Offset | 0.0 | N/A |
| SDI-12 Level Digits | 3 | 2 - 6 |
| Averaging Time | 2 Seconds | 1 - 360 seconds |
| Bubble Rate | 60 bubbles/min | 10 - 120 bubbles/min |
| Purge Pressure | 40 PSI (Amazon 150) 50 PSI (Amazon 300) 70 PSI (Amazon 500) | 40 - 90 PSI |
| Purge Sustain | 20 seconds | 10 - 30 seconds |
| 4 - 20mA Min Level | 4.0 | N/A |
| 4 - 20mA Max Level | 20.0 | N/A |

Reset to Defaults

It may be necessary to reset the Amazon settings back to factory defaults. To reset to defaults using the SDI-12 interface, send the "aXSDEF!" SDI-12 extended command. The response should be "a0041" which means that it will take 4 seconds to reset to defaults and then it will put 1 data value in the buffer. Note in Table 6-3, the 'a' is the current address of the Amazon.

Table 6-3: Reset Amazon to Factory Defaults

| Amazon SDI-12 Reset Command |
|-----------------------------|
| Command: aXSDEF! |
| Response: a0041 |

SDI-12 Address

The SDI-12 address of a sensor is its identifier on the SDI-12 data bus. The SDI-12 data bus is a one wire communication between normally one master device and one or more slave devices. The SDI-12 address makes it possible for the master device to communicate with each sensor individually. SDI-12 data collisions will occur when two or more sensors have the same address on the same data bus. The sensors with the same address will try to respond to the request of the master device at the same time and the result is garbage data. Therefore, it is important to know the address of the sensor to which communication is desired and that there are no other sensors with the same address.

The Amazon SDI-12 address by default is 0. To change the Amazon SDI-12 address using the SDI-12

interface, send the "aAn!" command and the response should be 'n', the new address. Note in Table 6-4, the 'a' is the current address of the Amazon and the 'n' is the desired new SDI-12 address.

Table 6-4: Change the Amazon SDI-12 Address

| Amazon SDI-12 Address Command |
|-------------------------------|
| Command: aAn! |
| Response: n |

Level Units/Slope

The level unit of a sensor is the setting that determines the data output units. Different data units are dependent on the slope/multiplier. The slope is multiplied by the raw data to achieve the desired units. For example, a pressure sensor raw data output might be in pressure (PSI) units, but the desired units by the user is feet. Therefore, the slope to convert PSI to Feet units for water depth is 2.0367 rounded.

The Amazon has a pressure sensor that measures the pressure required to push a bubble out of the orifice line, which is the line pressure. The line pressure raw value is returned in pressure (PSI) units. Normally, water depth in meters or feet is the level units desired. This then requires the line pressure value to be changed to a different set of units. Table 6-5 shows typical slopes required to convert pressure (PSI) units to other different level units.

Table 6-5: Amazon Level Units and Slopes

| Units | Slopes (multiplier) |
|-------------|---------------------|
| Feet | 2.3067 |
| Meters | 0.7031 |
| Inches | 27.6800 |
| Millimeters | 0.0007031 |
| Centimeters | 0.007031 |
| Feet down | -2.3067 |
| PSI | 1.0000 |

The Amazon level unit default is feet, which is a default slope of 2.0367. To change the Amazon level slope using the SDI-12 interface, send the "aXWSn.nn!" SDI-12 extended command. The response should be "a0021" which means that it will take 2 seconds to complete the command and then it will put 1 data value in the buffer. To check the slope and verify it was written correctly send "aXRS!" and wait the responded time. Then send the "aD0!" command to read back the new slope. Note Table 6-6, the 'a' is the current SDI-12 address of the Amazon and the 'nnnn'/'n.nnn' is the desired new units/slope.

CH6: SDI-12 INTERFACE

Table 6-6: Change the Amazon Level Units/Slope

| Amazon SDI-12 Level Units Commands |
|------------------------------------|
| Command: aXWSn.nnn! |
| Response: a0021 |
| Command: aXRS! |
| Response: a0011 |
| Command: aD0! |
| Response: a + n.nnn |

Set Current Level

Set current level is setting the water level reading to the actual measured or surveyed value, this could include the elevation (level) or not. Normally, the current level value comes from a wire weight reading or a surveyed staff gauge reading.

Setting the current level in the Amazon forces a new measurement and then compares the result of that measurement with the desired current level and then calculates and sets the level offset. To set current level using the SDI-12 interface, send the "aXSCSn.nn!" SDI-12 extended command. The response should be "a0061" which means that it will take 6 seconds to complete the command and then it will put 1 data value in the buffer. To check if the level was set correctly, send the "aM!" measurement command, wait the responded time and then send the "aD0" and verify the level value. Note Table 6-7, the 'a' is the current SDI-12 address of the Amazon and the 'n.nnn' is the desired new current level.

Table 6-7: Set the Amazon Current Level

| Amazon SDI-12 Current Level Commands |
|--------------------------------------|
| Command: aXSCSn.nnn! |
| Response: a0061 |
| Command: aM! |
| Response: a0066 |
| Command: aD0! |
| Response: a + n.nnn +... |

Note: The last section of this chapter discusses the "Set Current Level" section as the most used option.

Level Offset

The level offset is a value that is added to the final level result after the slope/multiplier has been applied. The level offset is normally used to obtain a final level relative to some reference point such as sea level. Writing the level offset is not needed when using the set current level option, because this option calculates and sets the level offset automatically.

The Amazon level offset default is 0.000. To change the Amazon level offset using the SDI-12 interface, send the "aXWOn.nnn!" SDI-12 extended command. The response should be "a0021" which means that it will take 2 seconds to complete the command and then it will put 1 data value in the buffer. To check the offset and verify it was written correctly send "aXRO!" and wait the responded time. Then send the "aD0!" command to read back the new offset. Note Table 6-8, the 'a' is the current SDI-12 address of the Amazon and the 'n.nnn' is the desired new level offset.

Table 6-8: Change the Amazon Level Offset

| Amazon SDI-12 Level Offset Commands |
|-------------------------------------|
| Command: aXWOn.nnn! |
| Response: a0021 |
| Command: aXRO! |
| Response: a0011 |
| Command: aD0! |
| Response: a + n.nnn |

Level Averaging Time

The level averaging time is the setting that determines how long in seconds the Amazon will average the measurements before returning the final level value. It is important to sample multiple times to ensure accuracy of a reading, especially if the water is rough. The level averaging time may need to be adjusted to help smooth out choppy data due to wave action.

The Amazon level averaging time default is 1 second, which is equal to about 15 samples. The level averaging time range is 1 to 360 seconds. To set the level averaging time using the SDI-12 interface, send the "aXWATnn!" SDI-12 extended command. The response should be "a0021" which means that it will take 2 seconds to complete the command and then it will put 1 data value in the buffer. To check if the averaging time was set correctly, send "aXRAT!" command, wait the responded time and then send the "aD0" and verify the averaging time value. Note Table 6-9, the 'a' is the current SDI-12 address of the Amazon and the 'n' is the desired level averaging time.

Note: This averaging time does not take into account the time it takes to make an atmospheric reading. Therefore, always add about 4 more seconds to the averaging time to calculate how long the full measurement cycle can take.

CH6: SDI-12 INTERFACE

Table 6-9: Change the Amazon Level Averaging Time

| SDI-12 Interface |
|-------------------|
| Command: aXWATn! |
| Response: a0021 |
| Command: aXRAT! |
| Response: a0011 |
| Command: aD0! |
| Response: a + nnn |

Bubble Rate

The bubble rate is the average number of bubbles flowing from the end of the orifice line per minute. The standard orifice line tubing that we recommend and calibrate the bubble rate has 1/8 inch inner diameter (I.D.). If a different size orifice I.D. is used the bubble rate will not be correct.

The bubble rate is a determining factor in the response time of the Amazon tracking a rise in level. Table 6-10 shows the approximate time needed to respond and track a one foot (0.305 m) rise in level with different bubble rates. Note at greater depths the time will increase slightly.

Table 6-10: Bubble Rate vs. Response Time

| Bubble Rate | Response for 1 Ft Rise |
|-----------------|------------------------|
| 30 bubbles/min | 25 seconds |
| 60 bubbles/min | 20 seconds |
| 120 bubbles/min | 15 seconds |

Another reason for changing the bubble rate may be to reduce noise in the data. Some sites have turbulent water conditions creating water level data that looks jittery. The bubble rate may be changed, up or down, to find optimal results to reduce this noise. Normally, it is a combination of changing the bubble rate and the mean count/samples to produce the best results. The default values normally work best in the majority of the applications and provide desirable results in a timely manner.

The Amazon bubble rate default is set to 60 bubbles/min. The bubble rate range is 10 to 120 bubbles/min. To change the Amazon bubble rate using the SDI-12 interface, send the "aXWBRnn!" SDI-12 extended command. The response should be "a0061" which means that it could take 6 seconds to complete the command and then it will put 1 data value in the buffer. To check the bubble rate and verify it was written correctly send "aXRBR!" command and wait the responded time. Then send the "aD0!" command to read back the new bubble rate. Note Table 6-11, the 'a' is the current SDI-12 address of the Amazon and the 'nn' is the desired bubble rate.

Table 6-11: Change the Amazon Bubble Rate

| Amazon SDI-12 Bubble Rate Command |
|-----------------------------------|
| Command: aXWBRnn! |
| Response: a0061 |
| Command: aXRBR! |
| Response: a0021 |
| Command: aD0! |
| Response: a + nn |

Purge

The Amazon has an option built in called purge, the purpose of the purge is to clear out any debris or silt from the end of the orifice line that could cause false pressure readings.

When a purge is initiated the Amazon makes a new measurement on the line and tank sensor and saves the values away just in case data is requested during the purge. The compressor is then turned on and begins compressing air into the tank until the tank pressure is equal to or greater than the purge pressure value. Then the purge valve is opened which then releases the tank pressure into the orifice line. The compressor will continue to run until the purge sustain timer has elapsed. Then the Amazon monitors the tank pressure which is still open to the orifice and waits for it to stabilize. Finally, the purge valve closes and the Amazon purge process is complete. Shortly following the purge sequence the Amazon will need to recharge the tank pressure to maintain the bubble rate and continue normal operation.

There are four ways to initiate a purge; push the "PURGE" button, timed interval, MODBUS command, and the SDI-12 command. The purge button is located on the front panel of the Amazon. Press and hold the button for 2 seconds.

To initiate a purge using the timed function refer to Chapter 4 and 5. To initiate a purge using the MODBUS commands refer to Chapter 7. To initiate a purge using the SDI-12 interface, send the "aXP!" command or the "aM2!" command. Note Table 6-12, the 'a' is the current SDI-12 address of the Amazon. The 'ttt' is the time it will take to complete the purge, which is dependent on other factors like averaging time and purge sustain. The 'dd.d' is the compressor battery voltage measured immediately following the completed purge sequence.

Table 6-12: Initiate Amazon Purge

| Amazon SDI-12 Purge commands |
|------------------------------|
| Command: aXP! / aM2! |
| Response: attt1 |
| Command: aD0! |
| Response: a + dd.d |

CH6: SDI-12 INTERFACE

Purge Pressure

The purge pressure is the pressure that is used to purge the orifice line. This is normally done to clear the end of the orifice line of debris and or sediment buildup. "False high level" readings can be caused by debris or sediment buildup at the end of the orifice line. This is because it will cause more restriction when trying to push a bubble out which is like the level is rising. This may cause a saw tooth profile in your data. As pressure keeps building up until the bubble pushes out past the debris or sediment relieving the pressure in the line. Then the pressure starts building up again causing saw tooth data.

The Amazon purge pressure default is set to 50 PSI. The programmable purge pressure range is 30 to 90 PSI. To change the Amazon purge pressure using the SDI-12 interface, send the "aXWPPnn!" SDI-12 extended command. The response should be "a0061", which means that it could take 6 seconds to complete the command and then it will put 1 data value in the buffer. To check the new purge pressure, send "aXRPP!" command and wait the responded time. Send the "aD0!" command to read back the new written purge pressure. Note Table 6-13, the 'a' is the current SDI-12 address of the Amazon and the 'nn' is the desired purge pressure.

Table 6-13: Change the Amazon Purge Pressure

| Amazon SDI-12 Purge Pressure Commands |
|---------------------------------------|
| Command: aXWPPnn! |
| Response: a0061 |
| Command: aXRPP! |
| Response: a0021 |
| Command: aD0! |
| Response: a + nn |

Purge Sustain

The purge sustain is part of the purge sequence discussed earlier, it is the time in seconds that the compressor will keep running after the tank pressure is released into the orifice line. The purge sustain helps clear out heavier sediment buildup and or bigger blocks at the end of the orifice because of sustaining a higher pressure.

The Amazon purge sustain default time is set to 20 seconds. The programmable purge sustain range is 10 to 30 seconds. To change the Amazon purge sustain using the SDI-12 interface; send the "aXWPSnn!" SDI-12 extended command. The response should be "a0061", which means that it could take 6 seconds to complete the command and then it will put 1 data value in the buffer. To check the new purge sustain time, send "aXRPS!" command and wait the responded time. Send the "aD0!" command to read back the new written purge sustain time. Note Table 6-14, the 'a' is the current SDI-12 address of the Amazon and the 'nn' is the desired purge sustain time.

Table 6-14: Change the Amazon Purge Sustain

| Amazon SDI-12 Purge Sustain Commands |
|--------------------------------------|
| Command: aXWPSnn! |
| Response: a0061 |
| Command: aXRPS! |
| Response: a0021 |
| Command: aD0! |
| Response: a + nn |

4-20 Milliamp Output

The Amazon has the ability to output the level value as a 4-20 milliamp signal. The 4-20 milliamp output is most commonly used in industrial applications with PLC's or SCADA systems. The Amazon controls the loop current but does not power the loop. Therefore, the loop must be externally powered. Figure 6-15 below shows a basic wiring diagram for a 4-20 milliamp output loop with the Amazon. The battery in the loop should be a +24VDC power source.

Figure 6-15: Typical Amazon 4-20mA Output Setup

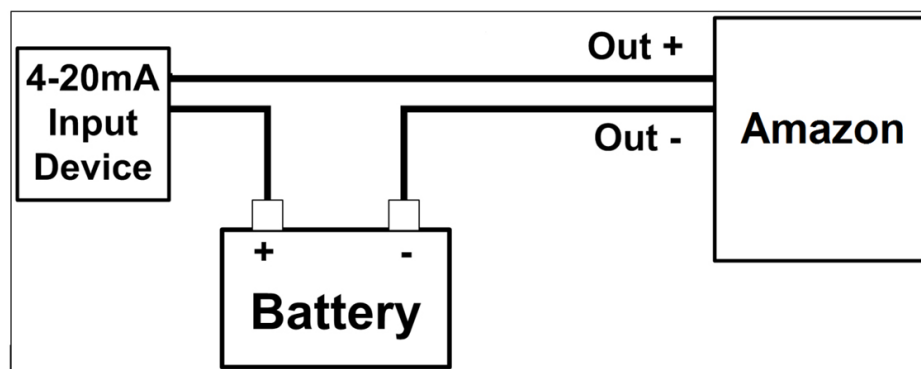

The Amazon scales the current measured level reading for the 4-20 milliamp output based on the 4-20 milliamp min and max level values.

4-20 Milliamp Min Level

The 4-20 milliamp min level value should be the lowest the level gets at the installed site. When the level equals this value or lower the 4-20 milliamp output will be 4.0 milliamps, the min.

The Amazon 4-20 milliamp min level default value is set to 4. There is no limit to this value, but keep in mind that the smaller the overall range of the 4-20 level scalar, which is the min to the max level, the higher the resolution of the 4-20 milliamp output. To change the Amazon 4-20 milliamp min level using the SDI-12 interface, send the "aXWILn.nn!" SDI-12 extended command. The response should be "a0021", which means that it could take 2 seconds to complete the command and then it will put 1 data

CH6: SDI-12 INTERFACE

value in the buffer. To check the new 4-20 milliamp min level, send "aXRIL!" command and wait the responded time. Then send the "aD0!" command to read back the new written 4-20 milliamp min level. Note Table 6-16, the 'a' is the current SDI-12 address of the Amazon and the 'n.nn' is the desired 4-20 milliamp min level.

Table 6-16: Change the Amazon 4-20 milliamp Min Level

| Amazon SDI-12 4-20mA Min Commands |
|-----------------------------------|
| Command: aXWILn.nn! |
| Response: a0021 |
| Command: aXRIL! |
| Response: a0011 |
| Command: aD0! |
| Response: a + n.nn |

4-20 Milliamp Max Level

The 4-20 milliamp max level value should be the highest the level gets at the installed site. When the level equals this value or greater the 4-20 milliamp output will be 20.0 milliamps, the max.

The Amazon 4-20 milliamp max level default value is set to 20. There is no limit to this value, but keep in mind that the smaller the overall range of the 4-20 level scalar, which is the min to the max level, the higher the resolution of the 4-20 milliamp output. To change the Amazon 4-20 milliamp max level using the SDI-12 interface, send the "aXWIHn.nn!" SDI-12 extended command. The response should be "a0021", which means that it could take 2 seconds to complete the command and then it will put 1 data value in the buffer. To check the new 4-20 milliamp max level, send "aXRIH!" command and wait the responded time. Then send the "aD0!" command to read back the new written 4-20 milliamp max level.

Table 6-17: Change the Amazon 4-20 milliamp Max Level

| Amazon SDI-12 4-20mA Max Commands |
|-----------------------------------|
| Command: aXWIHn.nn! |
| Response: a0021 |
| Command: aXRIH! |
| Response: a0011 |
| Command: aD0! |
| Response: a + n.nn |

Note: Table 6-17, the 'a' is the current SDI-12 address of the Amazon and the 'n.nn' is the desired **4-20 milliamp max level**.

Modbus Mode Enable

The Modbus mode enable is the setting that determines whether the Amazon will communicate with a Modbus master device. Modbus is an industry standard serial digital interface for interconnecting Programmable Logic Controllers (PLCs), intelligent sensors and other devices. The Amazon can be used as a Modbus slave and has both a Ethernet port and serial RS-485 port for connecting to a Modbus compatible host device. See the “Chapter 7 Modbus Operation” for more information on Modbus settings Modbus register definitions. Note: this mode requires more power because it does not go to sleep, the normal operation current draw increase to about 14mA instead of normal mode of about 6mA.

The Amazon Modbus mode enable default is 0 meaning disabled/off. To change the Amazon Modbus mode enable using the SDI-12 interface, send the “aXWME1!” SDI-12 extended command to enable or change the ‘1’ to a 0 to disable. The response should be “a0021” which means that it will take 2 seconds to complete the command and then it will put 1 data value in the buffer. To check the Modbus mode enable and verify it was written correctly send “aXRME!” and wait the responded time. Then send the “aD0!” command to read back the Modbus mode enable. Note Table 6-18, the ‘a’ is the current SDI-12 address of the Amazon and the ‘n’ is the desired Modbus mode enable “1 = On” or “0 = Off”.

Table 6-18: Change the Amazon Modbus Mode Enable

| Amazon SDI-12 Modbus Commands |
|-------------------------------|
| Command: aXWME _n ! |
| Response: a0021 |
| Command: aXRME! |
| Response: a0021 |
| Command: aD0! |
| Response: a + n |

Help

The Help command outputs a complete list of commands that this unit supports. The response is not SDI-12 compliant but many devices in a transparent mode can display the table of commands.

Table 6-19: Amazon Help

| Amazon SDI-12 Help Command |
|----------------------------|
| Command: aXHELP! |
| Response: a0021 |

07 / MODBUS OPERATION

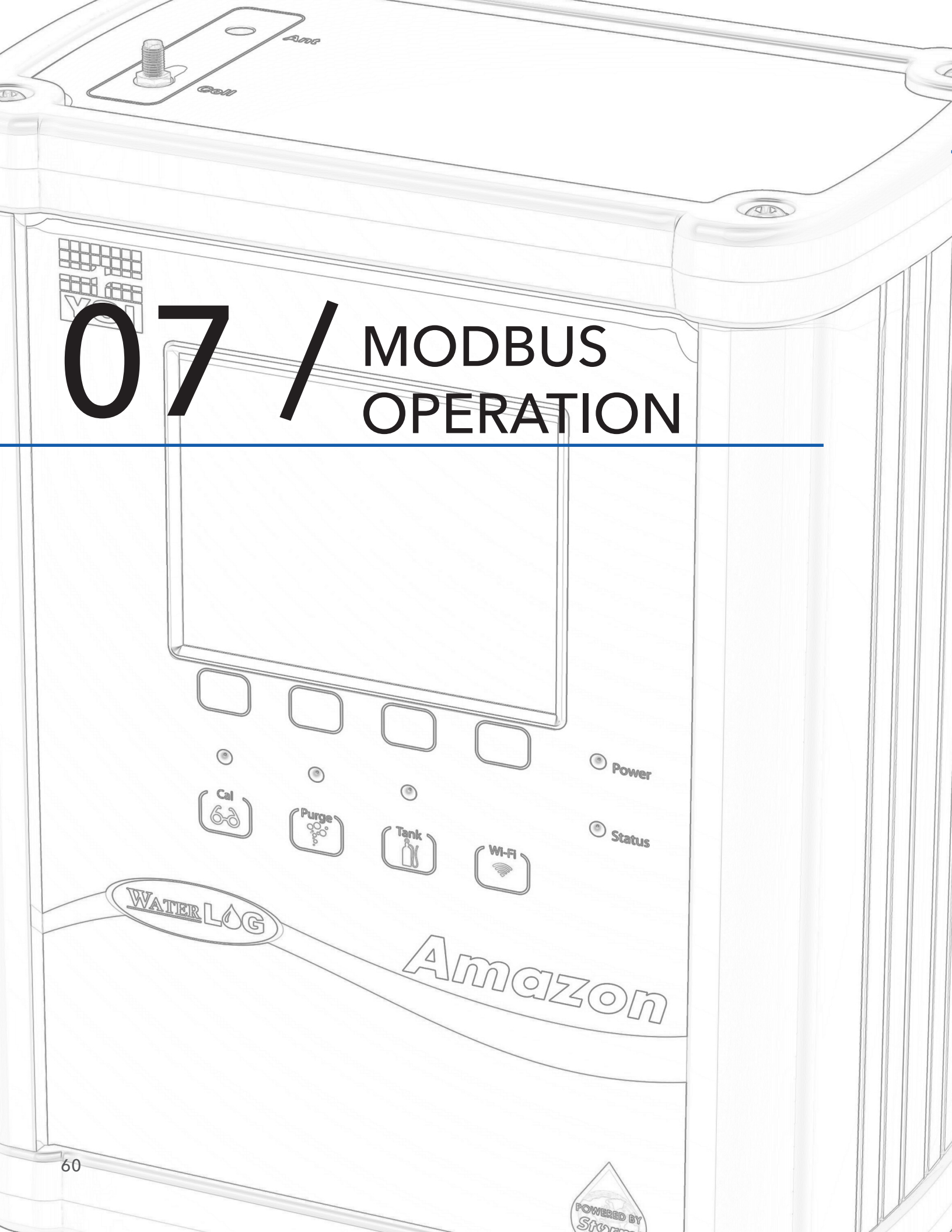

Modbus

The Amazon supports a Modbus client protocol interface. Modbus is an industry standard field bus for interconnecting Programmable Logic Controllers (PLCs), intelligent sensors and other devices. The Amazon communicates Modbus via the RS-485 serial port connections; see Chapter 2 Table 2-1 for wiring connections. This chapter will focus on Modbus setup and operation using the key pad and the SDI-12 interface.

Communication Setup

The Modbus communication interface is designed to work with a Modbus Host device like PLC's, etc. The host must support RTU (Remote Terminal Unit) mode to communicate with the Amazon. Table 7-1 shows the default settings required to communicate with the Amazon through the RS-485 Modbus interface port. For more information regarding Modbus RTU communication protocol and specifications see www.modbus.org.

Table 7-1: Amazon RS-485 Modbus Comm Settings

| Setting | Default Setting |
|-----------|-----------------|
| Baud Rate | 9600 |
| Data Bits | 8 |
| Stop Bits | 1 |
| Parity | Even |
| Protocol | RTU |

Function Codes

Modbus Function Codes are codes that are part of the Modbus command that specify what is being requested via the Modbus protocol. The Amazon supports two Modbus function codes. Table 7-2 shows the supported function codes.

Table 7-2: Amazon Supported Modbus Function Codes

| Function Code | Description | # of Registers |
|---------------|--------------------------|----------------|
| 03 | Read Holding Registers | 41 |
| 16 | Write Multiple Registers | 41 |

Holding Registers

The Amazon has 41 Holding Registers; these registers contain all the needed data for setup and measuring the Amazon. Table 7-3 is a list of the holding registers available.

Table 7-3: Amazon Holding Registers

| Register Description | Start Address | # of 16-bit Registers | Data Type |
|----------------------|---------------|-----------------------|---------------|
| *ID String | 0 / "0000" | 16 | Char String |
| Modbus Address | 16 / "0010" | 1 | Short Integer |

CH7: MODBUS OPERATION

Table 7-3: Amazon Holding Registers continued...

| Register Description | Start Address | # of 16-bit Registers | Data Type |
|----------------------|---------------|-----------------------|---------------|
| Level Units | 17 / "0011" | 1 | Short Integer |
| Reserved | 18 / "0012" | 1 | Short Integer |
| Baud Rate | 19 / "0013" | 1 | Short Integer |
| Parity | 20 / "0014" | 1 | Short Integer |
| Bubble Rate | 21 / "0015" | 1 | Short Integer |
| Purge Pressure | 22 / "0016" | 1 | Short Integer |
| Purge Sustain | 23 / "0017" | 1 | Short Integer |
| Purge | 24 / "0018" | 1 | Short Integer |
| Level Offset | 25 / "0019" | 2 | 32 Bit Float |
| Level Slope | 27 / "001B" | 2 | 32 Bit Float |
| *Level | 29 / "001D" | 2 | 32 Bit Float |
| *Pressure | 31 / "001F" | 2 | 32 Bit Float |
| *Temperature | 33 / "0021" | 2 | 32 Bit Float |
| *Control Battery | 35 / "0023" | 2 | 32 Bit Float |
| *Tank Pressure | 37 / "0025" | 2 | 32 Bit Float |
| *Compressor Battery | 39 / "0027" | 2 | 32 Bit Float |

*Note: These registers are read only; there is no effect if written.

ID String Registers

The ID String is the first set of registers in the Holding Registers; these registers return the same information that the SDI-12 ID command returns. The ID string consists of 16, 16-bit registers in ASCII character data format. These registers can be read separately but to get the full ID string the user must read all 16-registers at once. These registers are read only registers; however, writing to them will have no effect. As shown in Table 7-3 the response to reading the ID string is sent as ASCII character string.

Modbus Address Register

The Modbus Address holding register allows the user to change the Modbus address of the Amazon. A Modbus host / master device can be connected to many Modbus slave devices at one time. Therefore, the Modbus address is a device identifier. This register must be read and wrote as a short integer.

The default Modbus address for the Amazon is 1 and the programmable address range is: 1 - 247. Address "0" is reserved as the broadcast address meaning that all Modbus sensors must listen when commands are sent to address "0".

Level Units Select Register

The **Level Units** holding registers allows the user to change the units of the final measured level value. Table 7-4 shows what the level units holding register must be set to obtain the desired units.

Table 7-4: Level Units Select Register Options

| Register Value | Level Units |
|----------------|----------------|
| 00 | Feet (Default) |
| 01 | Meters |
| 02 | Inches |
| 03 | Millimeters |
| 04 | Centimeters |
| 05 | PSI |
| 06 | User Defined |

The Amazon default level units are in feet. In the case that there is a user defined units, first change the level units select to '06' and then write the slope manually. Writing the level slope before setting level units to user defined will have no effect. This register must be read and wrote as a short integer.

Baud Rate Select Register

The Baud Rate holding register allows the user to change the baud rate of the Modbus RS-485 serial port. Table 7-5 shows what the Modbus baud rate holding register should be set to get the desired baud rate.

Table 7-5: Baud Rate Select Register Options

| Register Value | Level Units |
|----------------|----------------|
| 00 | 9600 (Default) |
| 01 | 4800 |
| 02 | 2400 |
| 03 | 1200 |

The Amazon default baud rate is 9600. When the user changes the baud rate it does not take effect until the power is cycled. This register must be read and wrote as a short integer.

CH7: MODBUS OPERATION

Parity Select Register

The Parity holding register allows the user to change the parity of the Modbus RS-485 serial port communication. Table 7-6 shows what the parity holding register should be set to get the desired parity.

Table 7-6: Parity Select Register Options

| Register Value | Level Units |
|----------------|----------------|
| 00 | None |
| 01 | Even (Default) |
| 02 | Odd |

Bubble Rate Register

The Bubble Rate holding register allows the user to change the bubble rate. See Chapters 4 or 5 - Bubble Rate for more information. This register must be read and wrote as a short integer.

Purge Pressure Register

The Purge Pressure holding register allows the user to change the purge pressure. See Chapters 4 or 5 - Purge Pressure for more information. This register must be read and wrote as a short integer.

Purge Sustain Register

The Purge Sustain holding register allows the user to change the purge sustain time. See Chapters 4 or 5 - Purge Sustain for more information. This register must be read and wrote as a short integer.

Purge Register

The Purge holding register allows the user to initiate a purge sequence. Writing a '1' to this register will initiate a purge sequence. See Chapters 4 or 5 - Purge for more information. This register must be read and wrote as a short integer.

Level Offset Register

The Level Offset holding register allows the user to enter a user defined level offset. The factory default is 0. See Chapters 4 or 5 - Level Offset for more information. This holding register is a 32-bit holding register. Therefore, the value sent to write to this register must be in a 32-bit floating point number format.

Level Slope Register

The Level Slope holding register allows the user to enter a user defined level slope. Writing to this register is only applicable when the Level Units Select Register is set to 06, which indicates the user defined mode for the units. The factory default slope is 2.3067, which is the slope for level unit's feet. See Chapters 4 or 5 - Level Slope for more information. This holding register is a 32-bit holding register. Therefore, the value sent to write to this register must be in a 32-bit floating point number format.

Level Register

The Level holding register holds the current measured water level value. This holding register is a 32-bit holding register. Level is the result of the pressure in the line multiplied by the level slope and added to the level offset.

Pressure Register

The Pressure holding register holds the current measured pressure value before the slope and offset is applied. Therefore, it holds the raw PSI value. This holding register is a 32-bit holding register.

Temperature Register

The Temperature holding register holds the current measured temperature. The temperature reading is the temperature of the internal pressure sensor and may not accurately reflect air temperature.

Control Battery Register

The Control Battery holding register holds the current measured battery connected to the control circuit board or sensor interface cable power connections. This holding register is a 32-bit holding register.

Tank Pressure Register

The Tank Pressure holding register holds the current measured tank pressure value. This holding register is a 32-bit holding register.

Compressor Battery Register

The Compressor Battery holding register holds the current measured battery connected to the Amazon. This holding register is a 32-bit holding register.

Modbus Command Examples

Below are some examples of Modbus commands and their format.

Example #1: Read Holding Register Command:

Format: "aabbcccddeeee"

Where:

- aa = 1 byte Modbus address
- bb = 1 byte function code
- ccc = 2 byte start address
- ddd = 2 byte quantity of registers
- eee = 2 byte crc check

Example: 010300010001D5CA

CH7: MODBUS OPERATION

Example #2: Write Multiple Registers Command:

Format: "aabbccccddddeeffffgggg"

Where:

- aa = 1 byte Modbus address
- bb = 1 byte function code
- cccc = 2 byte start address
- dddd = 2 byte quantity of registers
- ee = byte count
- ffff = 2 byte data value
- gggg = 2 byte crc value

Example: 011000010001022000BE41

08 / APPENDIX

WATER LOG

Amazon



CH8: APPENDIX

Appendix A: Orifice Line Installation

Proper installation of the bubbler orifice line is critical to obtaining a reliable and accurate water level measurement and to provide long term stability in your measurement system.

Equipment

The equipment that is required for a successful installation includes five products:

1. **Outlet Fitting.** As mentioned in Chapter 2: Getting Started, the Amazon ships with the xxx Outlet Fitting. The Outlet Fitting insures the orifice line connects to the Amazon Outlet properly. To insure a proper fit, the orifice line must be cut with a clean 90° angle.

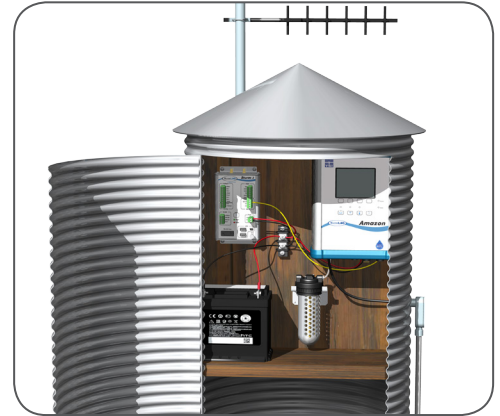

Gauge House Containing Amazon Bubbler



Outlet Fitting



Outlet Fitting with Orifice Line

2. **Orifice Line.** To maintain the published accuracy specification, a firm tube (do not use thin walled tubing) with 0.9525 cm (0.375 in) OD x 0.3175 cm (0.125 in) ID dimensions is required. The length of the line should be cut so as to run a downward sloping line between the bubbler and the bubble outlet. For best results, there should not be any dips in the line. Be sure the water current or flow is not pushing against the end of the orifice line, as it will cause a pressure to be placed on the line that is not related to water depth.

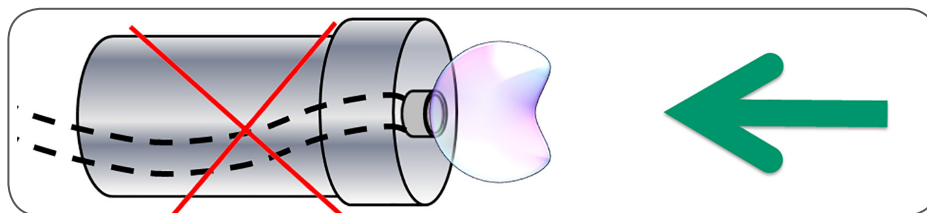

Be sure the water current is not pushing against the end of the orifice line

Also, be sure the water current or flow is not pulling or drawing from the end of the orifice line, as this will cause a false lower pressure on the line not related to the water level.

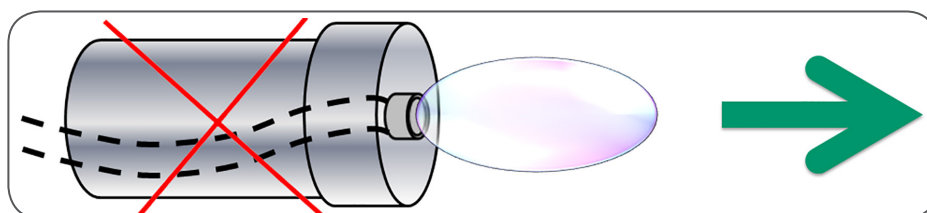

Be sure the water current is not pulling or drawing from the end of the orifice line

The line should be installed in an area where the flow of the water will remain relatively calm as compared to the real level changes. The optimal installation will place the line angled slightly down stream and perpendicular to the flow.

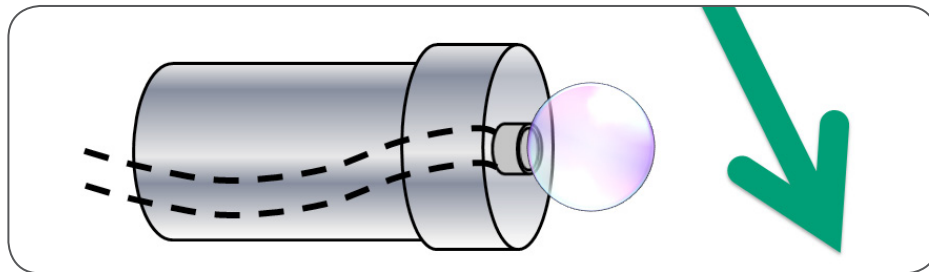

Optimal installation will place the line angled slightly down stream

3. **Desiccating Air Dryer.** It is imperative that the air intake is clean and dry. To insure all moisture is removed before the air is drawn into the air tank, an air desiccator must be used.



Desiccating Air Dryer

4. **Protective Pipe.** The orifice line is prone to damage by debris, animals, vandals, and other sources. A protective PVC or metal pipe as a conduit is recommended to protect the line and secure it in place.

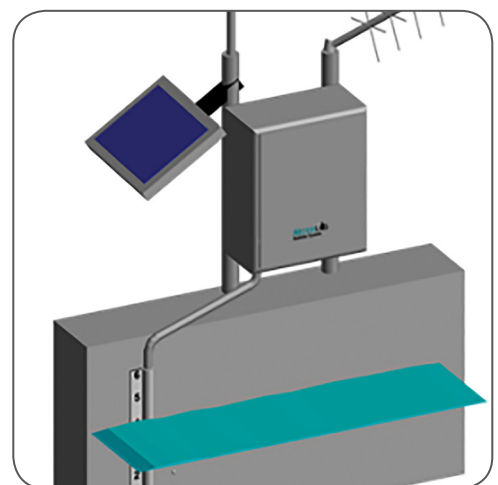

Protective Pipe

5. **Protective End Cap.** The end cap secures the orifice line to the conduit.

CH8: APPENDIX

Appendix B: Error Codes

The Amazon continually monitors its own health and status. Under Bubbler Settings on the browser screen and Bubbler Menu on the display, Error Codes provide diagnostic tool to manage the bubbler. In addition to the Error Code, an informative directive is posted on the main screens of the display when a problem occurs.

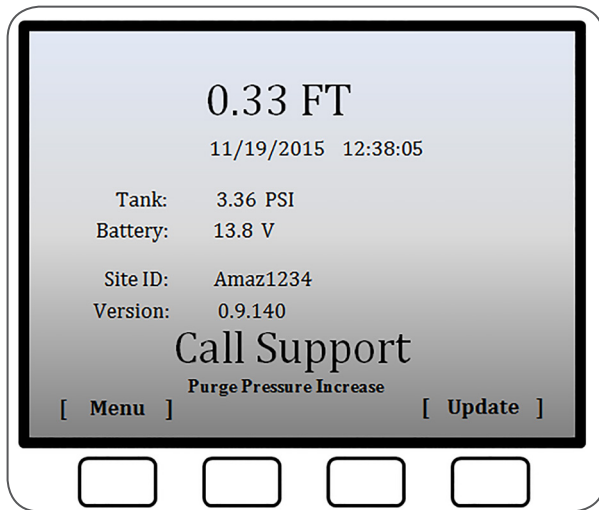

Error Code on Amazon Key Pad

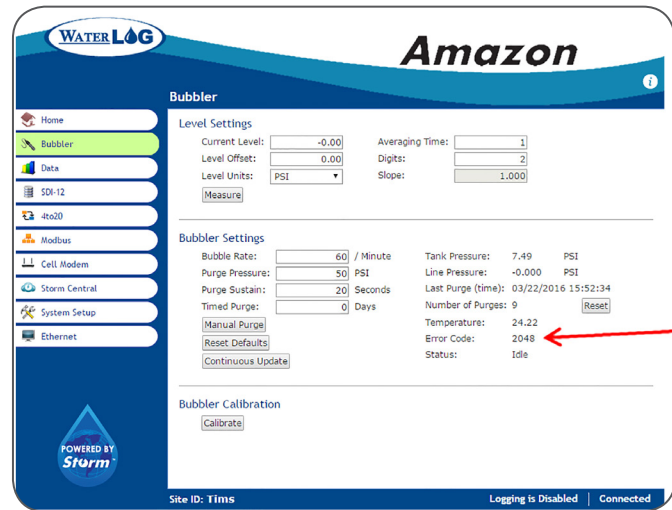

Error Code on Amazon GUI

The associated error code with this Directive is error code: 2048, as seen on both the Display and Software.

Directives

Directives provide a “call to do” action item for the user. The four possible directives are:

- **User Service.** These are action items that can be carried out by the user. The associated errors are:
 - o Low Battery. The battery could be dead or dying and needs to be service or replaced.
 - o High Battery. The battery could be receiving and unregulated charge which could damage the battery. The battery or regulatory needs to be service or charged.
 - o Memory Full. The Amazon’s internal memory is full. No additional data can be recorded. The data needs to be recorded to a PC, Storm Central, or to a USB Flash Drive, then the data record needs to be cleared (deleted) from the Amazon.
- **Factory Service.** The Amazon needs to be returned to the factory for repair. Call +1-937-767-2772 or email support@waterlog.com.
 - o Calibration Coefficients.
 - o Temperature Out of Range.
 - o Tank Sensor Out of Range.
 - o Purge Pressure Out of Range.
 - o Line Sensor Out of Range.
 - o Tank Auto Zero Out of Range.

- **Call Support.** Other mechanical causes have created a faulty system. These can often be fixed in the field with qualified technical support. These may be error created by a leak in the orifice line, or debris clogging the line.

- o Pressure Not Increasing.
- o Pressure Time Out. This happens during tank maintenance.
- o Purge Pressure Equalize Timeout.
- o Purge Pressure Increase. Pressure is not increasing during the purge cycle.
- o Compressor fault.

- **Set Clock.**

- o RTC Battery. The internal battery may be dead.

| Error Code | Description |
|------------|--|
| | User Service |
| 1 | High Battery |
| 2 | Low Battery |
| 4 | Memory Full |
| | Factory Service |
| 8 | Tank Sensor Out of Range |
| 16 | Line Sensor Out of Range |
| 32 | Temperature Out of Range |
| 64 | Purge Tank Pressure Out of Range |
| 128 | EEPROM Coefficient Read Failed |
| | Call Support |
| 256 | Maintenance Tank Pressure Not Increasing |
| 512 | Maintenance Tank Pressure Time Out |
| 1024 | Purge Tank Pressure Equalize Time Out |
| 2048 | Purge Tank Pressure Not Increasing |
| 4096 | Compressor Fault |
| 8192 | Tank Auto Zero Range |
| 16384 | Time Error |

If multiple errors have occurred the error code is a summation of the error codes. For example, if Low Battery and EEPROM Coefficients Read Failed the error code would be 130 (2 + 128).

CH8: APPENDIX

Appendix C: Specifications

| PERFORMANCE | | | |
|----------------------|--------------------------------|---|----------------------|
| Accuracy | Pressure | Less than or equal to 0.02% of full scale output (FSO) over temperature range | |
| Range | Pressure | Depth | Accuracy |
| | 0 to 15 PSI | 0 to 10.54 m (34.6 ft) | ±2.1 mm (0.007 ft) |
| | 0 to 30 PSI | 0 to 21 m (69.20 ft) | ±4.3 mm (0.014 ft) |
| | 0 to 50 PSI | 0 to 35.15 m (115.34 ft) | ±7.11mm (0.02333 ft) |
| Bubbler Gas Delivery | Microprocessor controlled unit | | |
| | Gas Flow Technology | Constant mass Technology | |
| | Gas Flow Control | Bubble rate is user programmable from 10 to 120 bubbles per minute based on 6.35 mm (1/4 in.) tubing. | |
| Purge Functions | Purge Pressure Level | User Selectable 40 PSI to 90 PSI | |
| | Options | <ul style="list-style-type: none"> • Manual • SDI driven purge • Purge sustain option (10 to 30 sec) • Automatic/programmable | |
| Compressor | Type | Piston Compressor | |
| | Operation | Low duty cycle (15 hours typical runtime per year at 60 bubbles per minute into 3.7 m (12 ft.) (purges not included) | |
| General | Pressure Overload | Up to 2 times the rated pressure | |
| | Media Capability | Non-corrosive dry gases only | |
| | Rating | NEMA 4 enclosure | |
| MECHANICAL / POWER | | | |
| Size | Housing | 311.15 mm L x 222.25 mm W x 146.05 mm H (12.25 in. L x 8.75 in. W x 5.75 in. H) | |
| Weight | Housing | 5.44kg (12.0 lbs) | |
| Material | Housing | Aluminum | |
| | Atmospheric Vent | Sintered bronze, #10-32 | |
| Power Requirements | Voltage Input | 10.0 to 16.5 V DC | |
| | Current | Standby: 6mA | |
| | | Compressor Active, No Pressure: 3 A | |
| | | Compressor Active, Full Pressure: 6 A | |
| | | Startup Surge Required: 15 A | |

| | | Based on a 60 bubbles/min flow rate with a 15 min measurement cycle and a 1 purge/day frequency. Average active current 20mA |
|---------------|--|--|
| | Surge Protection | 20 V DC |
| Connection | Quick Connect Phoenix Connectors | 2-position quick connect for power 5-position quick connect for SDI-12, 4 to 20mA, and RS-485 |
| | Pressure Inlet | 3.82 cm (1/8 in) female NPT |
| | | |
| COMMUNICATION | | |
| SDI-12 | Baud Rate | 1200 |
| | Protocol | SDI-12 V1.3, 7-bit even parity, 1 stop bit |
| | Output Voltage Levels | Minimum high level: 3.5 volts Maximum low Low: 0.8 volts |
| | Response Time | 8-second measurement sequence (programmable) |
| RS-485 | Baud Rate | Programmable (default = 9600) |
| | Protocol | Modbus RTU |
| 4-20mA Output | Type | 4-20mA, optically isolated |
| | Loop Voltage | 8.0V min, 35V max |
| | Resolution | ±0.24 uA (16-bit DAC) |
| | Accuracy | 0.075% max error |
| ENVIRONMENTAL | | |
| General | Operating Temperature | -40° to +60° C |
| | Compensated Range | -40° to +60° C |
| | Storage Temperature | -60° to + 80° C |
| MISCELLANEOUS | | |
| Warranty | The Amazon Bubbler is warranted against defects in materials and workmanship for two years from date of shipment. | |
| Note | Specifications subject to change without prior notice due to on going commitment to product testing and improvement. LR March 2016 (D59-04 0316) | |

This user manual is a guide for the Amazon Bubbler. For more information, updated manuals, brochures, technical notes, and supporting software on the Amazon Bubbler, please refer to ysi.com/Amazon or contact your sales representative.

For additional assistance, please contact us at +1.435.753.2212 or sales@waterlog.com

Xylem

- 1) The tissue in plants that brings water upward from the roots;
- 2) A leading global water technology company.

We're 12,000 people unified in a common purpose: creating innovative solutions to meet our world's water needs. Developing new technologies that will improve the way water is used, conserved, and re-used in the future is central to our work. We move, treat, analyze, and return water to the environment, and we help people use water efficiently, in their homes, buildings, factories and farms. In more than 150 countries, we have strong, long-standing relationships with customers who know us for our powerful combination of leading product brands and applications expertise, backed by a legacy of innovation.

For more information on how Xylem can help you, go to www.xylem.com



a xylem brand

YSI Incorporated
1700/1725 Brannum Lane
Yellow Springs, Ohio, 45387, USA

Request a Quote

Tel: +1.435.753.2212
Email: sales@waterlog.com
Internet: www.ysi.com/amazon

Place an Order

Tel: +1.937.767.7241
Email: orders@ysi.com

Customer Support

Tel: +1.937.767.2772
Email: support@waterlog.com

©2016 Xylem Inc.
Item#361756REF dwg#361756
August 2016 Rev D
D84-06 0816